



# SIMEX

SOLUCIONES HIDRAULICAS INTEGRALES



## Lista de Precios Mayo 2018



**SHI de México S. de R.L. de C.V.**

## **INDICE**

<b>VALVULAS.....</b>	<b>1</b>
<b>CODOS Y TAPAS CIEGAS.....</b>	<b>1</b>
<b>TEES, CRUCES Y REDUCCIONES.....</b>	<b>2</b>
<b>EXTREMIDADES Y CARRETES.....</b>	<b>3</b>
<b>TORNILLOS.....</b>	<b>3</b>
<b>JUNTAS GIBAULT, ABRAZADERAS, EMPAQUES, BRIDAS Y CONTRAMARCOS.....</b>	<b>4</b>
<b>ALCANTARILLADO.....</b>	<b>5</b>
<b>VALVULAS DE MARIPOSA MARCA SIMEX .....</b>	<b>6</b>
<b>VALVULAS DE MARIPOSA MARCA BRAY.....</b>	<b>6</b>
<b>VALVULAS ELIMINADORAS DE AIRE, DE ADMISION Y EXPULSION DE AIRE, VALVULAS AUTOMATICAS .....</b>	<b>7</b>
<b>ADAPTADOR BRIDADO UNIVERSAL, COPLE UNIVERSAL DE RANGO AMPLIO, ALCANTARILLADO POLIETILENO.....</b>	<b>8</b>
<b>ABRAZADERAS DE REPARACION DE ACERO INOXIDABLE, COLPE DE DESMONTAJE, JUNTAS TIPO DRESER, TUBERIA DE ACERO GALVANIZADO.....</b>	<b>9</b>

### VALVULAS

DIAMETRO		VASTAGO FIJO				VASTAGO SALIENTE RESILENTE	CHECK RESILENTE	CHECK BRONCE
pulg.	mm.	BRONCE	FLEXIBLE BRIDADA	FLEX C/VOL BRIDADA	FLEXIBLE ESPIGAS			
2	51	\$ 4,093	\$ 3,031	\$ 3,150	\$ 2,560	\$ 3,676	\$ 3,338	
2 1/2	64	\$ 4,302	\$ 3,534	\$ 3,653	\$ 3,001	\$ 4,286	\$ 3,477	
3	76	\$ 5,969	\$ 4,176	\$ 4,318	\$ 3,762	\$ 5,774	\$ 4,159	
4	102	\$ 8,163	\$ 5,136	\$ 5,352	\$ 4,872	\$ 7,887	\$ 5,883	
6	152	\$ 12,373	\$ 8,344	\$ 8,637	\$ 8,562	\$ 13,616	\$ 11,092	
8	203	\$ 21,542	\$ 15,693	\$ 16,228	\$ 14,705	\$ 22,128	\$ 20,304	
10	254	\$ 31,512	\$ 22,866	\$ 23,550		\$ 35,544	\$ 31,751	
12	305	\$ 45,224	\$ 33,753	\$ 34,732		\$ 50,050	\$ 47,827	
14	356		\$ 67,171	\$ 67,171			\$ 77,041	
16	406		\$ 84,848	\$ 84,848			\$ 140,229	
18	457		\$ 129,039	\$ 129,039				\$ 201,577
20	508		\$ 183,162	\$ 183,162				\$ 262,228
24	610		\$ 280,891	\$ 280,891				\$ 407,380
30	762		\$ 575,092	\$ 575,092				
36	914		\$ 886,234	\$ 886,234				

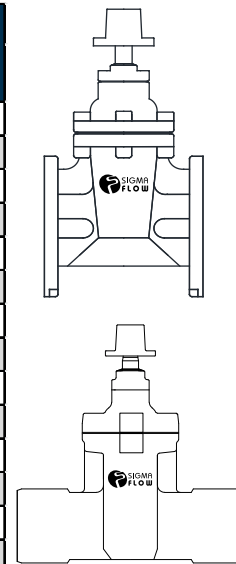

### CONEXIONES BRIDADAS



CODO 90



CODO 45



CODO 22 1/2



CODO 11 1/4



TAPAS CIEGAS 2 A 10"



TAPAS CIEGAS 12 A 36"

### CODOS

DIMENSION	GRADOS			
	90°	45°	22 1/2°	11 1/2°
2	\$ 715	\$ 536	\$ 570	\$ 570
2 1/2	\$ 918	\$ 882	\$ 882	\$ 882
3	\$ 1,152	\$ 921	\$ 894	\$ 894
4	\$ 2,011	\$ 1,788	\$ 1,788	\$ 1,601
6	\$ 2,905	\$ 2,459	\$ 2,459	\$ 2,380
8	\$ 4,694	\$ 4,023	\$ 4,023	\$ 4,023
10	\$ 7,493	\$ 5,811	\$ 6,034	\$ 6,034
12	\$ 10,504	\$ 8,816	\$ 9,164	\$ 8,295
14	\$ 15,314	\$ 11,688	\$ 13,455	\$ 13,455
16	\$ 19,639	\$ 14,845	\$ 16,937	\$ 15,699
18	\$ 26,570	\$ 19,956	\$ 20,056	\$ 19,956
20	\$ 32,040	\$ 22,792	\$ 27,721	\$ 27,721
24	\$ 47,691	\$ 33,314	\$ 40,621	\$ 41,002
30	\$ 98,516	\$ 77,077	\$ 78,450	\$ 79,363
36	\$ 147,011	\$ 120,860	\$ 123,599	\$ 124,667
42	Cotizar	Cotizar	Cotizar	Cotizar

### TAPAS CIEGAS

DIMENSION	PRECIO
2	\$ 197
2 1/2	\$ 296
3	\$ 402
4	\$ 683
6	\$ 1,084
8	\$ 1,846
10	\$ 2,760
12	\$ 3,692
14	\$ 5,360
16	\$ 7,455
18	\$ 9,676
20	\$ 10,971
24	\$ 19,422
30	\$ 34,336
36	\$ 64,332
42	Cotizar

### TEE, CRUCES Y REDUCCIONES

DIMENSION	TEE	CRUZ	RED.
2 x 2	\$ 860	\$ 1,384	

2 ½ x 2	\$ 1,454	\$ 1,492	\$ 667
2 ½ x 2 ½	\$ 1,481	\$ 1,720	

3 x 2	\$ 1,577	\$ 2,306	\$ 708
3 x 2 ½		\$ 2,387	\$ 853
3 x 3	\$ 1,843	\$ 2,387	

4 x 2	\$ 2,267	\$ 2,984	\$ 1,113
4 x 2 ½		\$ 2,984	\$ 1,116
4 x 3	\$ 2,661	\$ 3,153	\$ 1,416
4 x 4	\$ 2,933	\$ 3,641	

6 x 2	\$ 3,253	\$ 4,085	\$ 1,618
6 x 2 ½	\$ 3,253	\$ 4,085	\$ 1,618
6 x 3	\$ 3,843	\$ 4,085	\$ 1,820
6 x 4	\$ 4,040	\$ 4,927	\$ 2,023
6 x 6	\$ 4,237	\$ 5,744	

8 x 2	\$ 6,704	\$ 6,365	\$ 2,766
8 x 2 ½	\$ 6,192	\$ 6,456	\$ 2,766
8 x 3	\$ 6,192	\$ 6,745	\$ 2,815
8 x 4	\$ 6,473	\$ 6,898	\$ 2,933
8 x 6	\$ 6,675	\$ 7,391	\$ 3,302
8 x 8	\$ 7,080	\$ 8,958	

10 x 2 ½	\$ 9,414	\$ 9,652	\$ -
10 x 3	\$ 9,205	\$ 10,034	\$ 3,857
10 x 4	\$ 9,601	\$ 10,468	\$ 3,944
10 x 6	\$ 9,920	\$ 10,579	\$ 4,147
10 x 8	\$ 10,316	\$ 12,222	\$ 5,057
10 x 10	\$ 12,339	\$ 14,782	

12 x 3	\$ 13,162	\$ 13,533	\$ 5,526
12 x 4	\$ 13,932	\$ 14,025	\$ 5,620
12 x 6	\$ 13,553	\$ 14,125	\$ 5,967
12 x 8	\$ 14,261	\$ 15,207	\$ 6,675
12 x 10	\$ 16,486	\$ 17,204	\$ 7,788
12 x 12	\$ 17,699	\$ 20,596	

14 x 4	\$ 20,039	\$ 21,221	\$ 8,420
14 x 6	\$ 20,646	\$ 22,089	\$ 9,271
14 x 8	\$ 21,486	\$ 23,547	\$ 9,549
14 x 10	\$ 21,970	\$ 25,389	\$ 10,447
14 x 12	\$ 25,736	\$ 30,634	\$ 11,634
14 x 14	\$ 24,332	\$ 32,956	

16 x 4	\$ 25,253	\$ 26,666	\$ -
16 x 6	\$ 24,548	\$ 27,100	\$ 10,643
16 x 8	\$ 25,013	\$ 30,026	\$ 11,534
16 x 10	\$ 26,501	\$ 30,631	\$ 12,448
16 x 12	\$ 27,456	\$ 37,919	\$ 13,961
16 x 14	\$ 33,685	\$ 40,912	\$ 14,775
16 x 16	\$ 32,641	\$ 41,741	

DIMENSION	TEE	CRUZ	RED.
18 x 6	\$ 29,791	\$ 30,469	\$ 13,179
18 x 8	\$ 29,827	\$ 31,271	\$ 13,235
18 x 10	\$ 29,868	\$ 32,535	\$ 14,568
18 x 12	\$ 29,128	\$ 35,054	\$ 15,589
18 x 14	\$ 34,782	\$ 39,790	\$ 16,404
18 x 16	\$ 38,983	\$ 48,709	\$ 18,700
18 x 18	\$ 40,232	\$ 50,529	

20 x 6	\$ 40,122	\$ 41,178	\$ -
20 x 8	\$ 40,154	\$ 43,766	\$ 17,278
20 x 10	\$ 41,471	\$ 44,167	\$ 18,135
20 x 12	\$ 41,550	\$ 46,867	\$ 20,200
20 x 14	\$ 42,824	\$ 48,171	\$ 20,962
20 x 16	\$ 42,851	\$ 54,125	\$ 20,397
20 x 18	\$ 57,130	\$ 65,107	\$ 24,085
20 x 20	\$ 51,564	\$ 69,553	

24 x 6	\$ 61,975	\$ -	\$ -
24 x 8	\$ 63,284	\$ 65,212	\$ 31,773
24 x 10	\$ 63,337	\$ 67,882	\$ 32,378
24 x 12	\$ 57,096	\$ 70,519	\$ 32,690
24 x 14	\$ 67,793	\$ 68,309	\$ 33,744
24 x 16	\$ 67,255	\$ 74,502	\$ 30,017
24 x 18	\$ 83,315	\$ 93,957	\$ 31,403
24 x 20	\$ 95,319	\$ 116,755	\$ 40,233
24 x 24	\$ 96,120	\$ 123,009	

30 x 6	\$ 107,232	\$ -	\$ -
30 x 8	\$ 107,363	\$ -	\$ -
30 x 10	\$ 108,499	\$ -	\$ -
30 x 12	\$ 109,800	\$ 115,333	\$ -
30 x 14	\$ 110,397	\$ 115,737	\$ -
30 x 16	\$ 111,731	\$ 119,675	\$ 58,722
30 x 18	\$ 111,757	\$ 119,708	\$ 59,698
30 x 20	\$ 113,544	\$ 165,256	\$ 64,089
30 x 24	\$ 151,722	\$ 165,256	\$ 73,038
30 x 30	\$ 160,385	\$ 182,042	

36 x 12	\$ 166,880	\$ 172,312	\$ -
36 x 14	\$ 167,222	\$ 172,312	\$ -
36 x 16	\$ 168,069	\$ 174,516	\$ -
36 x 18	\$ 168,407	\$ 175,291	\$ 92,690
36 x 20	\$ 169,941	\$ 178,768	\$ 94,558
36 x 24	\$ 173,501	\$ 184,880	\$ 103,389
36 x 30	\$ 222,887	\$ 243,015	\$ 119,514
36 x 36	\$ 249,307	\$ 278,936	

42 x 12	Cotizar	Cotizar	Cotizar
42 x 14	Cotizar	Cotizar	Cotizar
42 x 16	Cotizar	Cotizar	Cotizar
42 x 18	Cotizar	Cotizar	Cotizar
42 x 20	Cotizar	Cotizar	Cotizar
42 x 24	Cotizar	Cotizar	Cotizar
42 x 30	Cotizar	Cotizar	Cotizar
42 x 36	Cotizar	Cotizar	Cotizar
42 x 42	Cotizar	Cotizar	

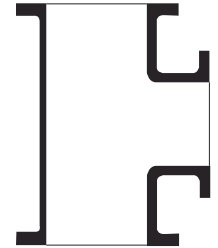

TEE

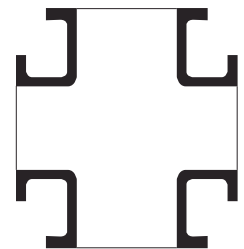

CRUZ

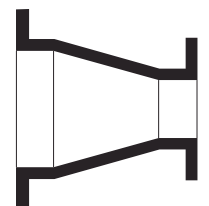

REDUCCION

### EXTREMIDADES Y CARRETES

DIMENSION	ASBESTO CEMENTO			PVC
	A5 - A7	A - 10	A - 14	
2	\$ 693	\$ 693	\$ 693	\$ 568
2 ½	\$ 926	\$ 926	\$ 926	\$ 828
3	\$ 944	\$ 944	\$ 944	\$ 944
4	\$ 1,072	\$ 1,072	\$ 1,072	\$ 1,072
6	\$ 1,639	\$ 1,639	\$ 1,639	\$ 1,639
8	\$ 2,856	\$ 2,856	\$ 2,856	\$ 2,719
10	\$ 4,451	\$ 4,451	\$ 4,451	\$ 4,247
12	\$ 6,008	\$ 6,008	\$ 6,008	\$ 5,730
14	\$ 10,075	\$ 10,073	\$ 11,227	\$ 9,597
16	\$ 15,656	\$ 15,656	\$ 15,656	\$ 14,238
18	Cotizar	Cotizar	Cotizar	\$ 17,781
20	Cotizar	Cotizar	Cotizar	Cotizar
24	\$ -	\$ -	\$ -	\$ 31,248
30	Cotizar	Cotizar	Cotizar	Cotizar
36	Cotizar	Cotizar	Cotizar	Cotizar

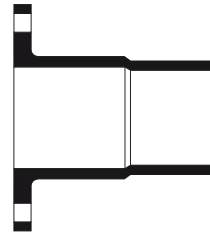

DIMENSION	LONGITUD	
	25 CMS.	50 CMS.
2	\$ 788	\$ 1,172
2 ½	\$ 1,032	\$ 1,567
3	\$ 1,448	\$ 2,344
4	\$ 1,652	\$ 2,547
6	\$ 2,425	\$ 3,179
8	\$ 4,043	\$ 5,074
10	\$ 5,534	\$ 8,302
12	\$ 7,770	\$ 9,491

### TORNILLOS

MEDIDA	PRECIO UNITARIO
7/16 x 4	\$ 13
7/16 x 4 ½	\$ 15

MEDIDA	PRECIO UNITARIO
7/8 x 4	\$ 67
7/8 x 6	\$ 111

1/2 x 2 ½	\$ 17
1/2 x 3	\$ 17
1/2 x 3 ½	\$ 17
1/2 x 4	\$ 18
1/2 x 4 ½	\$ 20
1/2 x 5	\$ 24
1/2 x 6	\$ 24

1 x 4	\$ 97
1 x 5	\$ 122
1 x 8	\$ 158

1 1/8 x 5	\$ 241
-----------	--------

1 ½ x 7	\$ 504
---------	--------

5/8 x 2 ½	\$ 20
5/8 x 3	\$ 24
5/8 x 3 ½	\$ 39
5/8 x 5	\$ 39
5/8 x 5 ½	\$ 51

3/4 x 3 ½	\$ 39
3/4 x 4	\$ 46
3/4 x 6	\$ 70

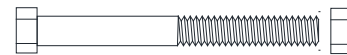

### JUNTAS GIBAULT, ABRAZADERAS, EMPAQUES, BRIDAS Y CONTRAMARCOS

#### JUNTAS GIBAULT

DIMENSION	A5 - A7	A - 10	A - 14	PVC
2	\$ 138	\$ 145	\$ 145	\$ 136
2 ½	\$ 155	\$ 172	\$ 172	\$ 155
3	\$ 180	\$ 180	\$ 212	\$ 180
4	\$ 262	\$ 262	\$ 280	\$ 262
6	\$ 445	\$ 445	\$ 445	\$ 445
8	\$ 655	\$ 655	\$ 804	\$ 655
10	\$ 840	\$ 974	\$ 1,100	\$ 820
12	\$ 1,132	\$ 1,132	\$ 1,183	\$ 1,120
14	\$ 1,817	\$ 1,832	\$ 1,893	\$ 1,538
16	\$ 2,013	\$ 2,172	\$ 2,369	\$ 1,893
18	\$ 2,437	\$ 2,791	\$ 3,183	\$ 2,271
20	\$ 3,291	\$ 3,697	\$ 4,263	\$ 3,183
24	Cotizar	Cotizar	Cotizar	Cotizar
30	Cotizar	Cotizar	Cotizar	Cotizar
36	Cotizar	Cotizar	Cotizar	ND

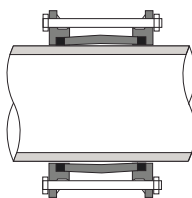

#### ABRAZADERAS

DIMENSION	AC 1/2 y 3/4"	PVC 1/2 y 3/4"
2	\$ 90	\$ 90
2 ½	\$ 94	\$ 94
3	\$ 116	\$ 116
4	\$ 146	\$ 146
6	\$ 204	\$ 204
8	\$ 274	\$ 274
10	\$ 339	\$ 339
12	\$ 537	\$ 537

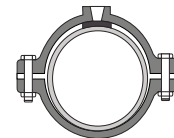

#### EMPAQUES

DIMENSION	PLOMO	NEOPRENO	GOMAS GIBAULT	
			NORMAL	REFORZADA
2	\$ 36	\$ 16	\$ 10	\$ 22
2 ½	\$ 43	\$ 21	\$ 12	\$ 31
3	\$ 53	\$ 29	\$ 14	\$ 33
4	\$ 72	\$ 36	\$ 20	\$ 39
6	\$ 90	\$ 41	\$ 33	\$ 67
8	\$ 171	\$ 72	\$ 40	\$ 80
10	\$ 254	\$ 126	\$ 63	\$ 126
12	\$ 330	\$ 152	\$ 76	\$ 171
14	\$ 467	\$ 196	\$ 94	\$ 310
16	\$ 600	\$ 312	\$ 118	\$ 341
18	\$ 698	\$ 398	\$ 162	\$ 361
20	\$ 884	\$ 438	\$ 190	\$ 421
24	\$ 1,157	\$ 583	\$ 250	\$ 710
30	\$ 1,762	\$ 995	\$ 452	\$ 1,173
36	\$ 2,219	\$ 1,361	\$ 564	\$ 1,271

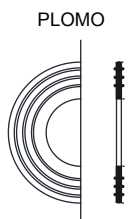

NEOPRENO

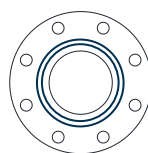

#### BRIDAS

DIMENSION	TIPO	
	C/ROSCA	SOLDABLE
2	\$ 207	\$ 188
2 ½	\$ 304	\$ 263
3	\$ 335	\$ 296
4	\$ 442	\$ 418
6	\$ 662	\$ 568
8	\$ 1,198	\$ 945
10	Cotizar	\$ 1,299
12	Cotizar	\$ 2,139
14		\$ 2,925
16		\$ 3,657
18		\$ 4,445
20		\$ 6,167
24		\$ 8,459
30		Cotizar
36		Cotizar



#### CONTRAMARCOS

DIMENSION	CENTRADO O DESCENT.	
	SENCILLO	DOBLE
4" x 0.90	\$ 1,255	
4" x 1.00	\$ 1,319	
4" x 1.10	\$ 1,394	
4" x 1.20	\$ 1,463	
4" x 1.30	\$ 1,535	
4" x 1.40	\$ 1,604	\$ 2,074
4" x 1.50	\$ 1,671	\$ 2,143
4" x 1.60	\$ 1,753	\$ 2,236
4" x 1.70	\$ 1,825	\$ 2,308
4" x 1.80	\$ 1,892	\$ 2,377
4" x 1.90	\$ 1,961	\$ 2,444
4" x 2.00	\$ 2,046	\$ 2,554
4" x 2.10	\$ 2,112	\$ 2,623

DIMENSION	CENTRADO O DESCENT.	
	SENCILLO	DOBLE
6" x 1.30	\$ 2,364	
6" x 1.40	\$ 2,469	
6" x 1.50	\$ 2,572	\$ 3,738
6" x 1.60	\$ 2,726	\$ 3,864
6" x 1.70	\$ 2,829	\$ 3,967
6" x 1.80	\$ 2,934	\$ 4,070
6" x 1.90	\$ 3,065	\$ 4,171
6" x 2.00	\$ 3,167	\$ 4,272
6" x 2.10	\$ 3,273	\$ 4,486
6" x 2.20	\$ 3,375	\$ 4,947
6" x 2.30	\$ 3,755	\$ 5,199
6" x 2.40	\$ 3,943	\$ 5,496

-SENCILLO CENTRADO  
-SENCILLO DESCENTRADO

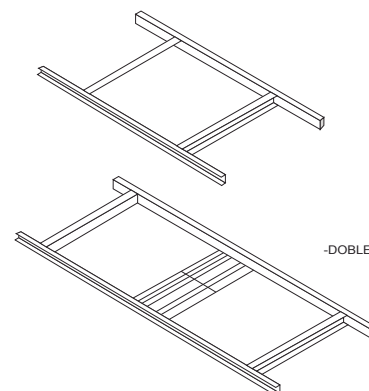

### ALCANTARILLADO

DESCRIPCION	PRECIO UNITARIO
BROCAL CON REJILLA DE DUCTIL	\$ 2,915
BROCAL CON REJILLA DE 80 KG.	\$ 2,065
BROCAL CON REJILLA DE 90 KG.	\$ 2,360
BROCAL CON REJILLA DE 110 KG.	\$ 2,950
BROCAL CON REJILLA DE 130 KG.	\$ 3,540
BROCAL CON REJILLA DE 150 KG.	\$ 4,130
BROCAL CON REJILLA DE 160 KG.	\$ 4,441

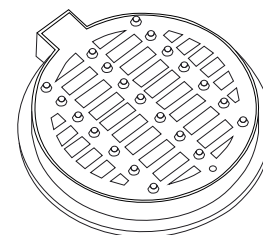

BROCAL CIEGO DE DUCTIL	\$ 2,915
BROCAL CIEGO DE 85 KG	\$ 2,213
BROCAL CIEGO DE 95 KG	\$ 2,508
BROCAL CIEGO DE 115 KG	\$ 3,098
BROCAL CIEGO DE 135 KG	\$ 3,688
BROCAL CIEGO DE 160 KG	\$ 4,425
BROCAL CIEGO DE 165 KG	\$ -

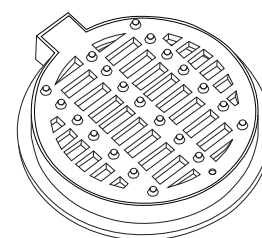

MARCO CON TAPA AP 50 X 50 CM DUCTIL	\$ 2,535
MARCO CON TAPA AP 50 X 50 CM DE 67 KG	\$ 1,977
MARCO CON TAPA AP 50 X 50 CM DE 80 KG	\$ 2,213
MARCO CON TAPA AP 50 X 50 CM DE 110 KG	\$ 2,950
MARCO CON TAPA AP 50 X 50 CM DE 130 KG	\$ 3,540

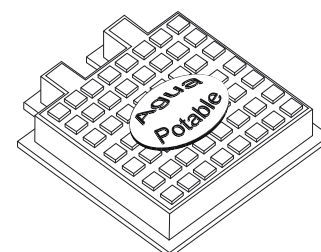

CAJA PARA LLAVE DE BANQUETA (BOTA LARGA)	\$ 193
CAJA PARA LLAVE DE BANQUETA (BOTA CORTA)	\$ 132
ESCALON PARA POZO DE VISITA LIGERO	\$ 86
ESCALON PARA POZO DE VISITA PESADO	\$ 136
COLADERA PLUVIAL	\$ 2,269
PLATO ROMPECHORRO COMPLETO	\$ 2,372
REGISTRO PARA VALVULA TELESCOPICO DE 61 A 92 CM.	\$ 1,968
REGISTRO PARA VALVULA TELESCOPICO DE 92 A 122 CM.	\$ 2,887

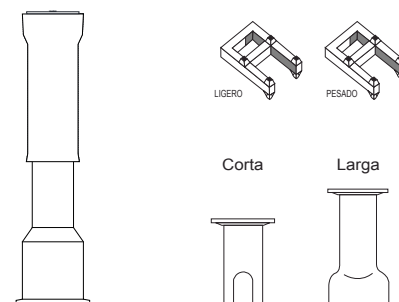

ARO Y TAPA CFE 84-B DE 105 KG	\$ 3,512
ARO Y TAPA CFE 84-B DE 120 KG	\$ 3,776
ARO Y TAPA CFE 84-B DE 135 KG	\$ 4,085
ARO Y TAPA CFE 84-B DE 110 KG CON BISAGRA	\$ 3,329
ARO Y TAPA CFE 84-B DE 125 KG CON BISAGRA	\$ 3,782
ARO Y TAPA CFE 84-B DE 140 KG CON BISAGRA	\$ 4,236

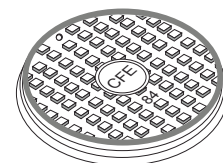

MARCO TAPA CFE 84-A DE 150 KG	\$ 5,136
MARCO TAPA CFE 84-A DE 180 KG	\$ 6,163
MARCO Y TAPA CFE 84-A DE 190 KG CON BISAGRA	\$ 6,506
MARCO Y TAPA REFORZADO CFE 84-A DE 250 KG	\$ 8,560
MARCO Y TAPA REFORZADO CFE 84-A DE 250 KG C/ BISAGRA	\$ 8,903

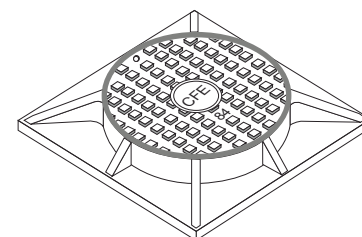

\*\*\*\*\* PRECIOS SUJETOS A CAMBIOS SIN PREVIO AVISO

### VALVULAS DE MARIPOSA SIGMA FLOW

PRECIOS DE LISTA UNITARIOS EN PESOS  
VALVULAS CON OPERADOR DE PALANCA  
VALVULAS NO INCLUYEN OPERADOR DE ENGRANES

Materiales	Valvula Mariposa	
<b>Cuerpo</b>	Hierro Gris	Hierro Gris
<b>Disco</b>	H. Ductil / Zinc	Ac. Inoxidable
<b>Vastago</b>	Ac. Inoxidable	Ac. Inoxidable
<b>Asiento</b>	Buna	Buna
<b>Presion</b>	250 PSI	250 PSI
<b>2"</b>	\$ 682	\$ 1,122
<b>2 1/2"</b>	\$ 756	\$ 1,146
<b>3"</b>	\$ 851	\$ 1,272
<b>4"</b>	\$ 1,006	\$ 1,748
<b>6"</b>	\$ 1,551	\$ 2,618
<b>8"</b>	\$ 2,909	\$ 5,095
<b>10"</b>	\$ 3,813	\$ 7,304
<b>12"</b>	\$ 5,297	\$ 10,654

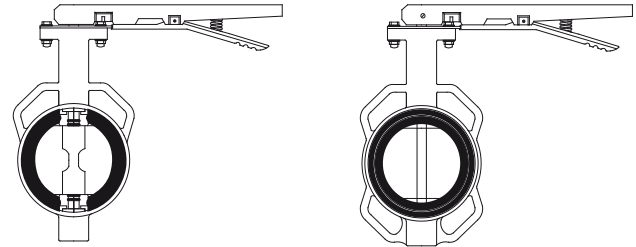

Operador de engranes	
<b>2"</b>	\$ 542
<b>2 1/2"</b>	\$ 587
<b>3"</b>	\$ 587
<b>4"</b>	\$ 587
<b>6"</b>	\$ 587
<b>8"</b>	\$ 1,039
<b>10"</b>	\$ 1,449
<b>12"</b>	\$ 1,449

### VALVULAS DE MARIPOSA MARCA BRAY

PRECIOS DE LISTA UNITARIOS EN DOLARES USA  
VALVULAS NO INCLUYEN OPERADOR DE ENGRANES

	Materiales		Tipo Oblea		
	Cuerpo	Hierro Gris	Hierro Gris		
	Disco	H. Ductil Nylon	Ac. Inoxidable		
	Vastago	Ac. Inoxidable	Ac. Inoxidable		
Asiento	EPDM / Buna	EPDM / Buna			
TAMAÑO VALVULA	PESO (LBS)	INCLUYE OPERADOR DE PALANCA		Operador de Engranes	
<b>2"</b>	6	\$ 102	\$ 119	\$ 133	
<b>2.5"</b>	9	\$ 108	\$ 122	\$ 133	
<b>3"</b>	10	\$ 115	\$ 135	\$ 133	
<b>4"</b>	14	\$ 142	\$ 179	\$ 133	
<b>6"</b>	22	\$ 200	\$ 265	\$ 133	
<b>8"</b>	38	\$ 294	\$ 494	\$ 189	
<b>10"</b>	51	\$ 424	\$ 807	\$ 189	
VASTAGO DESNUDO					
<b>12"</b>	71	\$ 524	\$ 1,172	\$ 189	
<b>14"</b>	114	\$ 725	\$ 1,605	\$ 257	
<b>16"</b>	193	\$ 1,033	\$ 2,163	\$ 295	
<b>18"</b>	222	\$ 1,444	\$ 3,140	\$ 521	
<b>20"</b>	315	\$ 1,897	\$ 3,852	\$ 521	
Cuerpo Bridado Inc. Op. De Engranes					
<b>24"</b>	506	\$ 5,403	\$ 10,275	\$ 558	
<b>30"</b>	610	\$ 10,217	\$ 18,953	\$ 2,197	
<b>36"</b>	1185	\$ 13,957	\$ 25,998	\$ 2,308	



### VALVULAS ELIMINADORAS DE AIRE Y VALVULAS DE ADMISION Y EXPULSION DE AIRE



DIMENSION	ELIMINADORAS	ADM. Y EXP DE AIRE	COMBINADAS
	200 PSI	200 PSI	200 PSI
1/2"	\$ 823	\$ 860	\$ 1,760
3/4"	\$ 823	\$ 883	\$ 1,760
1"	\$ 823	\$ 883	\$ 1,760
2"	\$ 1,666	\$ 1,247	\$ 2,721
3"		\$ 2,212	\$ 3,752
4"		\$ 3,795	\$ 6,108
6"		\$ 7,832	\$ 8,992
8"		Cotizar	Cotizar
10"		Cotizar	Cotizar

### VALVULAS AUTOMATICAS

#### CAMARA SENCILLA (Precios en Dolares USA)

DIMENSION	REDUCT. DE PRESION	FLOTADOR	ALIVIO Y CTRA GPE ARIETE
	250 lbs	250 lbs	250 lbs
2"	\$ 705	\$ 773	\$ 679
2 1/2"	\$ 842	\$ 794	\$ 712
3"	\$ 990	\$ 970	\$ 864
4"	\$ 1,254	\$ 1,254	\$ 1,196
6"	\$ 2,164	\$ 1,990	\$ 2,368
8"	\$ 3,333	\$ 3,042	\$ 3,236
10"	\$ -	\$ -	\$ -
12"	\$ -	\$ -	\$ -



#### CAMARA DOBLE, CUERPO EN "Y" (Precios en Dolares USA)

DIMENSION	REDUCT. DE PRESION	FLOTADOR	ALIVIO Y CTRA GPE ARIETE
	250 lbs	250 lbs	250 lbs
2"	\$ 1,143	\$ 1,083	\$ 908
2 1/2"	\$ 1,252	\$ 1,221	\$ 920
3"	\$ 1,417	\$ 1,398	\$ 1,097
4"	\$ 1,739	\$ 1,630	\$ 1,555
6"	\$ 3,174	\$ 2,979	\$ 3,212
8"	\$ 4,594	\$ 4,342	\$ 5,313
10"	\$ -	\$ -	\$ -
12"	\$ -	\$ -	\$ -



### ADAPTADOR BRIDADO UNIVERSAL Y COPLE UNIVERSAL DE RANGO AMPLIO

DIMENSION	RANGO	PRECIO UNITARIO
2"	48-60	\$ 450
	59-72	\$ 474
2 1/2"	72-85	\$ 485
3"	88-103	\$ 737
4"	96-116	\$ 816
	109-130	\$ 816
6"	159-184	\$ 1,164
8"	192-210	\$ 1,768
	218-235	\$ 1,768
10"	250-267	\$ 2,170
	250-274	\$ 2,170
	272-289	\$ 2,170
12"	315-332	\$ 2,683
	322-342	\$ 3,494
	324-365	\$ 3,494
14"	351-378	\$ 4,929
16"	390-410	\$ 5,805
	425-442	\$ 6,298
18"	436-463	\$ 9,858
	476-500	\$ 10,406
20"	500-508	\$ 11,501
	526-546	\$ 12,323
24"	608-636	\$ 14,787

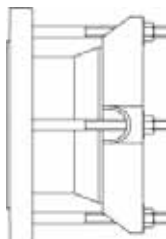

DIMENSION	RANGO	PRECIO UNITARIO
2"	48-60	\$ 386
	59-72	\$ 462
2 1/2"	72-85	\$ 509
3" - 4"	88-103	\$ 768
	96-116	\$ 836
4"	109-130	\$ 868
	118-135	\$ 868
6"	159-184	\$ 1,226
	173-193	\$ 1,226
8"	192-210	\$ 1,995
	218-235	\$ 1,995
8" - 10"	225-250	\$ 2,135
10"	242-262	\$ 2,307
	250-267	\$ 2,451
	272-289	\$ 2,524
10" - 12"	281-309	\$ 2,679
12"	315-332	\$ 2,912
	322-342	\$ 2,979
12"	332-354	\$ 3,315
14"	351-378	\$ 3,502
14" - 16"	390-410	\$ 5,574
16"	425-442	\$ 5,866
18"	454-463	\$ 6,803
18" - 20"	476-500	\$ 6,803
20"	500-508	\$ 7,270
	526-546	\$ 7,441
24"	608-636	\$ 8,403

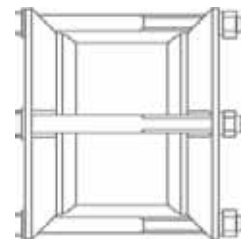

### ALCANTARILLADO POLIETILENO

DESCRIPCION	PRECIO UNITARIO
BROCAL CIEGO POLIETILENO MEDIA DENSIDAD	\$ 1,242
BROCAL CON REJILLA POLIETILENO MEDIA DENSIDAD	\$ 1,242
BROCAL CIEGO POLIETILENO HALO EXTENDIDO	\$ 1,718
MARCO CON TAPA AP 50 X 50 CM POLIETILENO	\$ 1,201

### LISTA DE PRECIOS ABRAZADERAS DE REPARACION DE ACERO INOXIDABLE

DIAMETRO	LARGO	RANGO EN MM	PRECIO UNITARIO
2	8	59-67	\$ 895
2.5	8	69-76	\$ 997
3	8	88-94	\$ 1,015
	8	95-105	\$ 1,015
4	8	113-123	\$ 1,217
	8	120-131	\$ 1,217
	8	132-142	\$ 1,217
6	8	155-175	\$ 1,503
	8	166-177	\$ 1,503
	8	170-190	\$ 1,503
	8	173-194	\$ 1,503
	8	179-189	\$ 1,503
8	8	205-225	\$ 1,804
	8	218-228	\$ 1,804
	8	235-246	\$ 1,804

DIAMETRO	LARGO	RANGO EN MM	PRECIO UNITARIO
10	8	246-257	\$ 2,361
	8	271-282	\$ 2,361
	12	280-290	\$ 3,399
	12	288-298	\$ 3,399
	12	322-332	\$ 3,949
12	12	334-364	\$ 3,949
	12	345-355	\$ 4,483
14	12	388-419	\$ 5,572
16	12	434-465	\$ 6,664
18	12	495-525	\$ 7,133
20	12	495-525	\$ 11,689
	24	590-621	\$ 13,712
24	24	620-650	\$ 14,790

### CARRETES DE DESMONTAJE

DIMENSION	PRECIO UNITARIO
4"	\$ 2,593
6"	\$ 3,827
8"	\$ 5,085
10"	\$ 7,101
12"	\$ 11,564

### FILTROS"Y"

DIMENSION	PRECIO UNITARIO
2"	\$ 1,058
2 1/2"	\$ 1,379
3"	\$ 1,783
4"	\$ 2,507
6"	\$ 5,262
8"	\$ 10,109
10"	\$ 17,707
12"	\$ 20,767

### JUNTAS TIPO DRESER

DISPONIBLES DE 2" A 48"  
COTIZAR DE ACUERDO A DIAMETRO EXTERIOR DE TUBERIA

### TUBERIA DE ACERO GALVANIZADO

DISPONIBLES EN GRADO A Y GRADO B  
LONGITUD DE 6.4 MTS