



SIMEX

HACIENDO LA EXCELENCIA UN HABITO



Lista de Precios Marzo 2023



SHI de México S. de R.L. de C.V.

INDICE

VALVULAS.....	1
CODOS Y TAPAS CIEGAS.....	1
TEES, CRUCES Y REDUCCIONES.....	2
EXTREMIDADES CARRETES Y TORNILLOS	3
JUNTAS GIBAULT, ABRAZADERAS FO.FO., EMPAQUES, BRIDAS Y ABRAZADERAS CUERPO HIERRO DUCTIL CON BANDA ACERO INOXIDABLE	4
ADAPTADOR BRIDADO UNIVERSAL, COPLE UNIVERSAL DE RANGO AMPLIO Y ADAPTADOR PARA PEAD	5
VALVULAS DE MARIPOSA	6
VALVULAS ELIMINADORAS DE AIRE, DE ADMISION Y EXPULSION DE AIRE Y VALVULAS AUTOMATICAS	7
ABRAZADERAS DE REPARACION DE ACERO INOXIDABLE, COPLE DE DESMONTAJE, FILTRO TIPO Y	8
ALCANTARILLADO.....	9
CONTRAMARCOS, ALCANTARILLADO POLIETILENO JUNTAS TIPO DRESER	10

VALVULAS

DIAMETRO		VASTAGO FIJO					VASTAGO SALIENTE RESILIENTE	CHECK RESILIENTE	CHECK BRONCE
pulg.	mm.	BRONCE	BRONCE C/VOLANTE	FLEXIBLE BRIDADA	FLEX C/VOL BRIDADA	FLEXIBLE ESPIGAS			
2	51	\$ 5,246	\$ 5,505	\$ 3,294	\$ 3,525	\$ 2,688	\$ 5,017	\$ 3,350	
2 1/2	64	\$ 5,520	\$ 5,820	\$ 3,934	\$ 4,159	\$ 3,151	\$ 6,261	\$ 4,146	
3	76	\$ 7,652	\$ 7,952	\$ 4,935	\$ 5,203	\$ 3,950	\$ 8,181	\$ 5,312	
4	102	\$ 10,079	\$ 10,478	\$ 6,616	\$ 7,020	\$ 5,115	\$ 10,772	\$ 7,329	
6	152	\$ 15,299	\$ 15,857	\$ 10,588	\$ 11,173	\$ 8,990	\$ 18,185	\$ 14,616	
8	203	\$ 26,606	\$ 27,236	\$ 17,631	\$ 18,370	\$ 15,440	\$ 28,230	\$ 27,165	
10	254	\$ 38,902	\$ 40,669	\$ 28,790	\$ 29,843		\$ 39,586	\$ 37,149	
12	305	\$ 55,817	\$ 58,198	\$ 40,033	\$ 41,448		\$ 57,076	\$ 53,098	
14	356	\$ 104,832	\$ 106,674	\$ 79,963	\$ 80,836			\$ 78,054	
16	406	\$ 129,794	\$ 131,636	\$ 96,175	\$ 96,857			\$ 140,229	
18	457	\$ 197,381	\$ 199,918	\$ 156,747	\$ 157,415				\$ 201,577
20	508	\$ 240,381	\$ 240,381	\$ 217,981					\$ 262,228
24	610	\$ 350,037	\$ 350,037	\$ 298,634					\$ 407,380
30	762	\$ 807,704		\$ 753,587					\$ 695,527
36	914	\$ 1,217,306		\$ 1,060,427					\$ 1,221,096

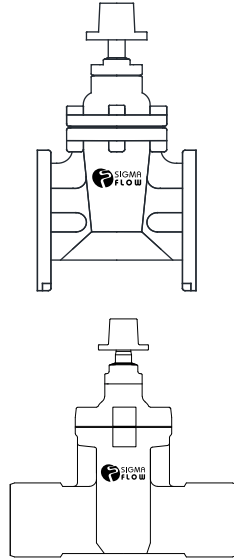

CONEXIONES BRIDADAS

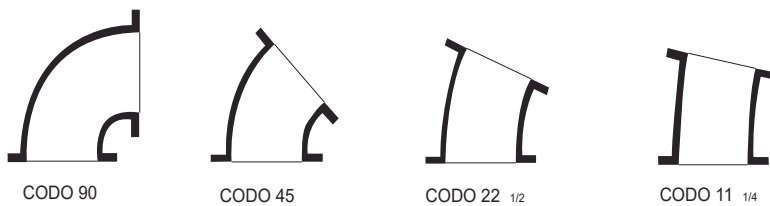

CODOS

DIMENSION	GRADOS			
	90°	45°	22 1/2°	11 1/2°
2	\$ 1,163	\$ 836	\$ 836	\$ 836
2 1/2	\$ 1,393	\$ 1,115	\$ 998	\$ 998
3	\$ 1,816	\$ 1,452	\$ 1,393	\$ 1,393
4	\$ 3,268	\$ 2,905	\$ 2,905	\$ 2,905
6	\$ 4,721	\$ 3,996	\$ 3,996	\$ 3,996
8	\$ 7,628	\$ 6,537	\$ 6,537	\$ 6,537
10	\$ 11,985	\$ 9,805	\$ 9,805	\$ 9,406
12	\$ 17,069	\$ 14,164	\$ 14,892	\$ 14,284
14	\$ 24,053	\$ 18,247	\$ 18,213	\$ 18,213
16	\$ 30,689	\$ 23,225	\$ 23,068	\$ 23,068
18	\$ 37,325	\$ 27,606	\$ 27,116	\$ 27,116
20	\$ 49,265	\$ 36,524	\$ 35,210	\$ 35,210
24	\$ 76,447	\$ 53,512	\$ 51,804	\$ 52,194
30	Cotizar	Cotizar	Cotizar	Cotizar
36	Cotizar	Cotizar	Cotizar	Cotizar
42	Cotizar	Cotizar	Cotizar	Cotizar

TAPAS CIEGAS

DIMENSION	PRECIO
2	\$ 320
2 1/2	\$ 461
3	\$ 653
4	\$ 1,017
6	\$ 1,744
8	\$ 2,761
10	\$ 4,285
12	\$ 5,520
14	\$ 9,123
16	\$ 12,027
18	\$ 15,344
20	\$ 17,999
24	\$ 30,689
30	\$ 40,473
36	\$ 64,332
42	Cotizar

TEE, CRUCES Y REDUCCIONES

DIMENSION	TEE	CRUZ	RED.
2 x 2	\$ 1,601	\$ 1,843	

2 ½ x 2	\$ 1,843	\$ 1,997	\$ 1,075
2 ½ x 2 ½	\$ 1,997	\$ 2,304	

3 x 2	\$ 2,562	\$ 3,072	\$ 1,121
3 x 2 ½	\$ 2,611	\$ 3,226	\$ 1,601
3 x 3	\$ 2,883	\$ 4,148	

4 x 2	\$ 3,683	\$ 4,148	\$ 1,762
4 x 2 ½	\$ 3,840	\$ 4,455	\$ 1,997
4 x 3	\$ 4,324	\$ 4,916	\$ 2,242
4 x 4	\$ 4,644	\$ 5,765	

6 x 2	\$ 5,530	\$ 5,991	\$ 2,562
6 x 2 ½	\$ 5,684	\$ 6,298	\$ 2,611
6 x 3	\$ 6,245	\$ 6,605	\$ 2,883
6 x 4	\$ 6,566	\$ 8,007	\$ 3,203
6 x 6	\$ 6,886	\$ 8,648	

8 x 2	\$ 7,681	\$ 8,449	\$ 3,687
8 x 2 ½	\$ 7,681	\$ 7,991	\$ 3,687
8 x 3	\$ 9,608	\$ 9,985	\$ 4,148
8 x 4	\$ 10,249	\$ 10,753	\$ 4,644
8 x 6	\$ 10,569	\$ 12,011	\$ 5,445
8 x 8	\$ 11,210	\$ 14,092	

10 x 2	\$ 12,289	\$ 13,825	
10 x 2 ½	\$ 12,289	\$ 10,724	\$ -
10 x 3	\$ 13,518	\$ 14,286	\$ 5,684
10 x 4	\$ 14,893	\$ 15,361	\$ 6,245
10 x 6	\$ 15,694	\$ 17,455	\$ 6,566
10 x 8	\$ 16,334	\$ 19,217	\$ 8,007
10 x 10	\$ 19,537	\$ 24,021	

12 x 3	\$ 21,352	\$ 20,782	\$ 8,141
12 x 4	\$ 21,139	\$ 21,659	\$ 8,648
12 x 6	\$ 21,459	\$ 23,220	\$ 9,448
12 x 8	\$ 22,580	\$ 24,982	\$ 10,569
12 x 10	\$ 26,103	\$ 30,106	\$ 12,331
12 x 12	\$ 28,025	\$ 33,469	

14 x 4	\$ 29,444	\$ 29,730	\$ 12,313
14 x 6	\$ 30,337	\$ 32,300	\$ 12,492
14 x 8	\$ 31,986	\$ 34,441	\$ 14,098
14 x 10	\$ 32,300	\$ 37,296	\$ 15,347
14 x 12	\$ 34,441	\$ 40,865	\$ 18,726
14 x 14	\$ 36,023	\$ 42,828	

16 x 4	\$ 37,118	\$ 34,644	\$ -
16 x 6	\$ 38,583	\$ 39,616	\$ 15,221
16 x 8	\$ 39,314	\$ 42,115	\$ 16,953
16 x 10	\$ 41,143	\$ 40,261	\$ 20,037
16 x 12	\$ 43,154	\$ 48,896	\$ 22,472
16 x 14	\$ 42,828	\$ 50,845	\$ 23,782
16 x 16	\$ 45,532	\$ 54,862	

DIMENSION	TEE	CRUZ	RED.
18 x 4	\$ 37,653		
18 x 6	\$ 38,902	\$ 39,586	\$ 19,273
18 x 8	\$ 40,152	\$ 43,364	\$ 19,451
18 x 10	\$ 41,222	\$ 41,635	\$ 21,414
18 x 12	\$ 44,434	\$ 46,135	\$ 25,093
18 x 14	\$ 49,368	\$ 52,290	\$ 26,404
18 x 16	\$ 52,643	\$ 64,006	\$ 27,481
18 x 18	\$ 55,223	\$ 50,529	

20 x 4	\$ 48,182		
20 x 6	\$ 49,431	\$ 51,138	\$ 23,912
20 x 8	\$ 50,145	\$ 51,138	\$ 24,448
20 x 10	\$ 51,394	\$ 54,428	\$ 25,162
20 x 12	\$ 53,357	\$ 57,718	\$ 27,838
20 x 14	\$ 53,892	\$ 60,317	\$ 28,731
20 x 16	\$ 67,109	\$ 66,408	\$ 33,146
20 x 18	\$ 66,384	\$ 79,882	\$ 33,192
20 x 20	\$ 81,084	\$ 85,342	

24 x 6	\$ 68,347		\$ -
24 x 8	\$ 69,596	\$ 80,810	\$ 37,296
24 x 10	\$ 71,202	\$ 70,526	\$ 44,023
24 x 12	\$ 73,874	\$ 73,819	\$ 38,902
24 x 14	\$ 90,210	\$ 89,060	\$ 39,616
24 x 16	\$ 74,057	\$ 92,362	\$ 48,182
24 x 18	\$ 112,227	\$ 116,126	\$ 50,137
24 x 20	\$ 101,539	\$ 144,316	\$ 58,866
24 x 24	\$ 110,263	\$ 127,057	

30 x 6	Cotizar	Cotizar	
30 x 8	Cotizar	Cotizar	
30 x 10	Cotizar	Cotizar	
30 x 12	Cotizar	Cotizar	
30 x 14	Cotizar	Cotizar	
30 x 16	Cotizar	Cotizar	Cotizar
30 x 18	Cotizar	Cotizar	Cotizar
30 x 20	Cotizar	Cotizar	Cotizar
30 x 24	Cotizar	Cotizar	Cotizar
30 x 30	Cotizar	Cotizar	

36 x 12	Cotizar	Cotizar	
36 x 14	Cotizar	Cotizar	
36 x 16	Cotizar	Cotizar	
36 x 18	Cotizar	Cotizar	Cotizar
36 x 20	Cotizar	Cotizar	Cotizar
36 x 24	Cotizar	Cotizar	Cotizar
36 x 30	Cotizar	Cotizar	Cotizar
36 x 36	Cotizar	Cotizar	

42 x 12	Cotizar		
42 x 14	Cotizar	Cotizar	Cotizar
42 x 16	Cotizar	Cotizar	Cotizar
42 x 18	Cotizar	Cotizar	Cotizar
42 x 20	Cotizar	Cotizar	Cotizar
42 x 24	Cotizar	Cotizar	Cotizar
42 x 30	Cotizar	Cotizar	Cotizar
42 x 36	Cotizar	Cotizar	Cotizar
42 x 42	Cotizar	Cotizar	Cotizar

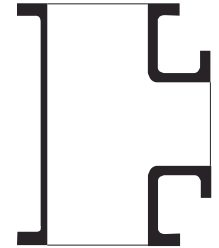

TEE

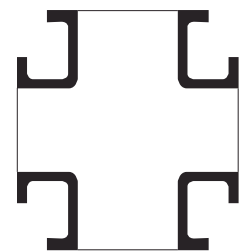

CRUZ

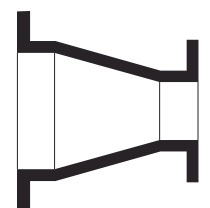

REDUCCION

EXTREMIDADES Y CARRETES

EXTREMIDAD

DIMENSION	ASBESTO CEMENTO			PVC
	A5 - A7	A - 10	A - 14	
2	\$ 793	\$ 906	\$ 906	\$ 620
2 ½	\$ 1,023	\$ 1,232	\$ 1,232	\$ 828
3	\$ 1,140	\$ 1,140	\$ 1,140	\$ 1,140
4	\$ 1,430	\$ 1,430	\$ 1,430	\$ 1,430
6	\$ 2,188	\$ 2,188	\$ 2,188	\$ 2,188
8	\$ 3,813	\$ 3,813	\$ 3,813	\$ 3,629
10	\$ 5,941	\$ 5,941	\$ 5,941	\$ 5,668
12	\$ 8,015	\$ 8,015	\$ 8,015	\$ 7,647
14	\$ 12,543	\$ 12,543	\$ 12,543	\$ 11,952
16	\$ 19,825	\$ 19,825	\$ 19,825	\$ 17,726
18	Cotizar	Cotizar	Cotizar	\$ 22,141
20	Cotizar	Cotizar	Cotizar	Cotizar
24	Cotizar	Cotizar	Cotizar	\$ 36,344
30	Cotizar	Cotizar	Cotizar	Cotizar
36	Cotizar	Cotizar	Cotizar	Cotizar

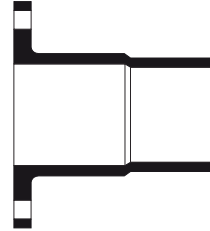

CARRETE

DIMENSION	LONGITUD	
	25 CMS.	50 CMS.
2	\$ 1,148	\$ 1,557
2 ½	\$ 1,379	\$ 2,165
3	\$ 1,901	\$ 2,786
4	\$ 2,047	\$ 3,334
6	\$ 3,032	\$ 4,618
8	\$ 5,762	\$ 8,764
10	\$ 6,891	\$ 10,249
12	\$ 9,681	\$ 14,194



TORNILLOS

MEDIDA	PRECIO UNITARIO
7/16 x 4	\$ 21
7/16 x 4 ½	\$ 23

MEDIDA	PRECIO UNITARIO
7/8 x 4	\$ 91
7/8 x 6	\$ 121

1/2 x 2 ½	\$ 19
1/2 x 3	\$ 19
1/2 x 3 ½	\$ 21
1/2 x 4	\$ 23
1/2 x 4 ½	\$ 28
1/2 x 5	\$ 31
1/2 x 6	\$ 38

1 x 4	\$ 123
1 x 5	\$ 141
1 x 8	\$ 229

1 1/8 x 5	\$ 327
-----------	--------

1 ½ x 7	\$ 575
---------	--------

5/8 x 2 ½	\$ 31
5/8 x 3	\$ 34
5/8 x 3 ½	\$ 39
5/8 x 5	\$ 53
5/8 x 5 ½	\$ 55

3/4 x 3 ½	\$ 50
3/4 x 4	\$ 61
3/4 x 6	\$ 80

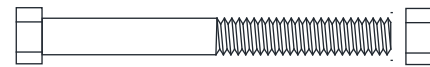

JUNTAS GIBAULT, ABRAZADERAS, EMPAQUES, BRIDAS

JUNTAS GIBAULT

DIMENSION	A5 - A7	A - 10	A - 14	PVC
2	\$ 208	\$ 223	\$ 223	\$ 184
2 ½	\$ 223	\$ 252	\$ 252	\$ 223
3	\$ 252	\$ 252	\$ 308	\$ 252
4	\$ 373	\$ 373	\$ 373	\$ 357
6	\$ 638	\$ 686	\$ 686	\$ 638
8	\$ 958	\$ 984	\$ 984	\$ 832
10	\$ 1,227	\$ 1,330	\$ 1,572	\$ 977
12	\$ 1,587	\$ 1,772	\$ 1,864	\$ 1,572
14	\$ 2,483	\$ 2,578	\$ 2,700	\$ 1,864
16	\$ 2,718	\$ 2,819	\$ 3,426	\$ 2,578
18	\$ 3,259	\$ 4,226	\$ 4,248	\$ 2,797
20	\$ 4,463	\$ 4,566	\$ 6,133	\$ 3,667
24	Cotizar	Cotizar	Cotizar	Cotizar
30	Cotizar	Cotizar	Cotizar	Cotizar
36	Cotizar	Cotizar	Cotizar	ND

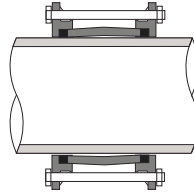

ABRAZADERAS

DIMENSION	FoFo AC 1/2 y 3/4" NPT	FoFo PVC 1/2 y 3/4" NPT
2	\$ 122	\$ 122
2 ½	\$ 140	\$ 130
3	\$ 195	\$ 140
4	\$ 219	\$ 218
6	\$ 310	\$ 275
8	\$ 407	\$ 407
10	\$ 555	\$ 520
12	\$ 783	\$ 629

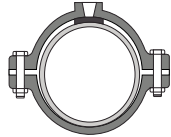

EMPAQUES

DIMENSION	PLOMO	NEOPRENO	GOMAS GIBAULT	
			NORMAL	REFORZADA
2	\$ 53	\$ 20	\$ 12	\$ 25
2 ½	\$ 64	\$ 26	\$ 14	\$ 34
3	\$ 75	\$ 36	\$ 16	\$ 42
4	\$ 105	\$ 45	\$ 20	\$ 57
6	\$ 130	\$ 51	\$ 33	\$ 75
8	\$ 249	\$ 89	\$ 40	\$ 105
10	\$ 366	\$ 165	\$ 63	\$ 150
12	\$ 477	\$ 195	\$ 87	\$ 208
14	\$ 679	\$ 292	\$ 146	\$ 367
16	\$ 873	\$ 401	\$ 158	\$ 408
18	\$ 1,033	\$ 466	\$ 196	\$ 461
20	\$ 1,264	\$ 562	\$ 211	\$ 529
24	\$ 1,686	\$ 748	\$ 322	\$ 839
30	\$ 2,529	\$ 1,307	\$ 745	\$ 1,598
36	\$ 3,156	\$ 1,477	\$ 991	\$ 2,020

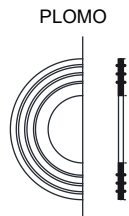

NEOPRENO

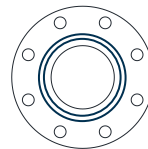

BRIDAS

DIMENSION	TIPO	
	C/ROSCA	SOLDABLE
2	\$ 330	\$ 300
2 ½	\$ 417	\$ 360
3	\$ 442	\$ 405
4	\$ 656	\$ 601
6	\$ 854	\$ 772
8	\$ 1,454	\$ 1,293
10	\$ -	\$ 1,789
12	\$ -	\$ 2,929
14	\$ -	\$ 3,869
16	\$ -	\$ 5,009
18	\$ -	\$ 5,578
20	\$ -	\$ 7,061
24	\$ -	\$ 9,912
30	\$ -	\$ 28,003
36	\$ -	\$ 43,502



ABRAZADERA CUERPO HIERRO DUCTIL CON BANDA ACERO INOXIDABLE

DIMENSION	RANGO TUBERIA	ROSCA	
		NPT 1/2"	NPT Y MUELLER 3/4"
2"	60-77	\$ 342	\$ 357
2 ½" - 3"	77-95	\$ 360	\$ 375
3" - 4"	98-119	\$ 382	\$ 397
4"	114-130	\$ 395	\$ 409
4"	120-135	\$ 404	\$ 418
6"	160-190	\$ 437	\$ 452
8"	200-230	\$ 683	\$ 683
8" - 10"	225-250	\$ 729	\$ 729
10"	270-300	\$ 776	\$ 776
12"	320-340	\$ 791	\$ 791
12"	335-365	\$ 793	\$ 793

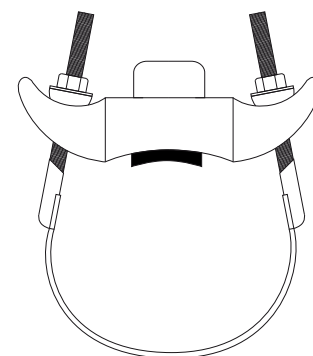

ADAPTADOR BRIDADO UNIVERSAL Y COPE UNIVERSAL DE RANGO AMPLIO

DIMENSION	RANGO	PRECIO	
			UNITARIO
2"	48 - 60	\$	491
	59 - 72	\$	491
2 1/2"	72 - 85	\$	550
3"	88 - 103	\$	663
	88 - 107	\$	872
4"	96 - 116	\$	734
	109 - 130	\$	734
	107 - 135	\$	1,022
6"	159 - 184	\$	1,174
	157 - 189	\$	1,512
8"	192 - 210	\$	1,591
	218 - 235	\$	1,591
	214 - 249	\$	1,727
10"	245 - 267	\$	2,405
	272 - 289	\$	2,405
	272 - 308	\$	2,615
12"	315 - 332	\$	2,707
	322 - 342	\$	3,145
	325 - 365	\$	4,829
14"	351 - 378	\$	5,275
	374 - 391	\$	5,611
16"	390 - 410	\$	5,698
	390 - 435	\$	6,516
	425 - 442	\$	7,139
18"	445 - 472	\$	9,365
	480 - 510	\$	9,886
20"	500-532	\$	10,926
	527-544	\$	11,707
24"	608-636	\$	14,048

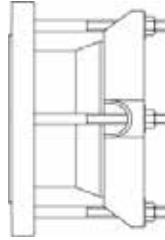

DIMENSION	RANGO	PRECIO	
			UNITARIO
2"	48 - 60	\$	512
	59 - 73	\$	512
2 1/2"	72 - 85	\$	523
3"	88 - 103	\$	691
	87 - 107	\$	781
3" - 4"	96 - 116	\$	752
4"	109 - 130	\$	781
	107 - 135	\$	950
6"	159 - 184	\$	1,166
	159 - 189	\$	1,323
8"	192 - 209	\$	1,796
	218 - 235	\$	1,796
	214 - 249	\$	2,174
10"	230 - 247	\$	2,380
	245 - 267	\$	2,739
	272 - 289	\$	2,998
12"	272 - 308	\$	3,288
	315 - 332	\$	3,374
12" - 14"	322 - 342	\$	3,386
	324 - 365	\$	4,664
14"	351 - 378	\$	5,976
	390 - 410	\$	5,816
16"	390 - 435	\$	7,173
	425 - 442	\$	6,110
18"	454 - 463	\$	6,463
	476 - 493	\$	7,101
20"	500 - 532	\$	6,907
	527 - 544	\$	8,093
24"	608 - 636	\$	9,367

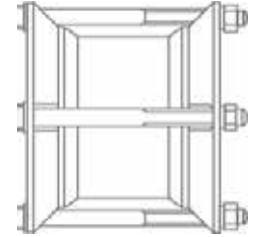

ADAPTADOR BRIDADO PARA PEAD

DIMENSION	Diam. Exterior Tubo PEAD	UNITARIO
3"	89	\$ 997
4"	114	\$ 1,440
6"	168	\$ 2,407

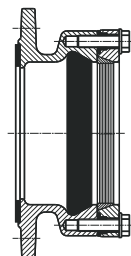

COPE PARA PEAD

DIMENSION	Diam. Exterior Tubo PEAD	UNITARIO
4"	114	\$ 1,671
6"	168	\$ 2,840
12"	315	\$ 7,929

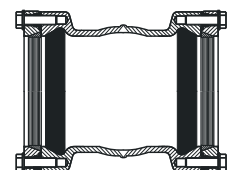

VALVULAS DE MARIPOSA SIGMA FLOW

PRECIOS DE LISTA UNITARIOS EN PESOS

VALVULAS CON OPERADOR DE PALANCA

VALVULAS NO INCLUYEN OPERADOR DE ENGRANES

Materiales	Valvula Mariposa	
	Hierro Gris	Hierro Gris
Cuerpo	H. Ductil / Rilsan	Ac. Inoxidable
Disco	H. Ductil / Rilsan	Ac. Inoxidable
Vástago	Acero C/Zinc	Ac. Inoxidable
Asiento	Buna	EPDM / Buna
Presion	150 PSI	150 PSI
2"	\$ 682	\$ 1,122
2 1/2"	\$ 760	\$ 1,146
3"	\$ 870	\$ 1,272
4"	\$ 1,190	\$ 1,757
6"	\$ 1,842	\$ 3,026
8"	\$ 2,909	\$ 5,095
10"	\$ 4,386	\$ 8,444
12"	\$ 5,957	\$ 12,527

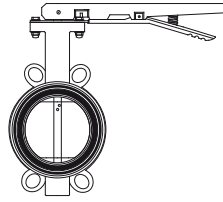

Operador de engranes	
2"	\$ 719
2 1/2"	\$ 719
3"	\$ 719
4"	\$ 719
6"	\$ 719
8"	\$ 1,292
10"	\$ 1,292
12"	\$ 1,808

VALVULAS DE MARIPOSA AWWA C504

PRECIOS DE LISTA UNITARIOS EN DOLARES USA

Materiales	Valvula Mariposa AWWA C504	
	Hierro Dúctil	Hierro Dúctil
Cuerpo	H. Dúctil Perfil AI	H. Dúctil
Disco	H. Dúctil Perfil AI	H. Dúctil
Vástago	Ac. Inoxidable	Ac. Inoxidable
Asiento	EPDM	EPDM
Presión	250 PSI	150 PSI
4"	\$ 383	
6"	\$ 571	
8"	\$ 888	
10"	\$ 1,154	
12"	\$ 1,633	
14"	\$ 2,310	
16"	\$ 3,412	
18"	\$ 4,080	
20"	\$ 6,241	
24"	\$ 7,974	
30"		\$ 18,777
36"		\$ 23,571
42"		\$ 32,197
48"		\$ 40,818

VALVULAS DE MARIPOSA MARCA BRAY

PRECIOS DE LISTA UNITARIOS EN DOLARES USA

VALVULAS NO INCLUYEN OPERADOR DE ENGRANES

TAMAÑO VALVULA	PESO (LBS)	Materiales		Tipo Oblea	
		Cuerpo	Hierro Dúctil	Hierro Dúctil	Hierro Dúctil
		Disco	H. Ductil Nylon	Ac. Inoxidable	Ac. Inoxidable
		Vástago	Ac. Inoxidable	Ac. Inoxidable	Ac. Inoxidable
		Asiento	EPDM / Buna	EPDM / Buna	EPDM / Buna
2"	6	\$ 108	\$ 127	\$ 167	
2.5"	9	\$ 116	\$ 131	\$ 167	
3"	10	\$ 123	\$ 146	\$ 167	
4"	14	\$ 151	\$ 191	\$ 169	
6"	22	\$ 214	\$ 282	\$ 142	
8"	38	\$ 312	\$ 526	\$ 245	
10"	51	\$ 451	\$ 858	\$ 203	
VASTAGO DESNUDO					
12"	71	\$ 557	\$ 1,247	\$ 203	
14"	114	\$ 772	\$ 1,707	\$ 275	
16"	193	\$ 1,098	\$ 2,301	\$ 314	
18"	222	\$ 1,617	\$ 3,339	\$ 597	
20"	315	\$ 2,019	\$ 4,096	\$ 597	
Cuerpo Bridado Inc. Op. De Engranés					
24"	506	\$ 5,745	\$ 10,926	\$ 593	
30"	610	\$ 10,865	\$ 20,154	\$ 2,336	
36"	1185	\$ 14,842	\$ 27,647	\$ 2,403	

VALVULAS ELIMINADORAS DE AIRE Y VALVULAS DE ADMISION Y EXPULSION DE AIRE

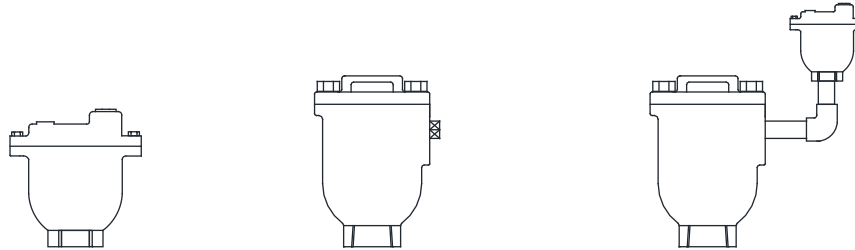

DIMENSION	ELIMINADORAS	ADM. Y EXP DE AIRE	COMBINADAS
	200 PSI	200 PSI	200 PSI
1/2"	\$ 998	\$ 1,039	\$ 2,037
3/4"	\$ 998	\$ 1,039	\$ 2,037
1"	\$ 998	\$ 1,039	\$ 2,037
2"	\$ 1,237	\$ 1,470	\$ 2,721
3"	-	\$ 2,606	\$ 3,752
4"	-	\$ 4,464	\$ 6,108
6"	-	\$ 8,149	\$ 9,850
8"	-	Cotizar	Cotizar
10"	-	Cotizar	Cotizar

VALVULAS AUTOMATICAS

CAMARA SENCILLA (Precios en Dolares USA)

DIMENSION	REDUCT. DE PRESION	FLOTADOR	ALIVIO Y CTRA GPE ARIETE
	250 lbs	250 lbs	250 lbs
2"	Cotizar	Cotizar	Cotizar
2 1/2"	Cotizar	Cotizar	Cotizar
3"	Cotizar	Cotizar	Cotizar
4"	Cotizar	Cotizar	Cotizar
6"	Cotizar	Cotizar	Cotizar
8"	Cotizar	Cotizar	Cotizar
10"	Cotizar	Cotizar	Cotizar
12"	Cotizar	Cotizar	Cotizar



CAMARA DOBLE, CUERPO EN "Y" (Precios en Dolares USA)

DIMENSION	REDUCT. DE PRESION	FLOTADOR	ALIVIO Y CTRA GPE ARIETE
	250 lbs	250 lbs	250 lbs
2"	Cotizar	Cotizar	Cotizar
2 1/2"	Cotizar	Cotizar	Cotizar
3"	Cotizar	Cotizar	Cotizar
4"	Cotizar	Cotizar	Cotizar
6"	Cotizar	Cotizar	Cotizar
8"	Cotizar	Cotizar	Cotizar
10"	Cotizar	Cotizar	Cotizar
12"	Cotizar	Cotizar	Cotizar



ABRAZADERAS DE REPARACION DE ACERO INOXIDABLE

DIAMETRO	LARGO	RANGO EN MM	PANEL	PRECIO UNITARIO
2	8	59-67	Simple	\$ 895
2.5	8	69-76	Simple	\$ 997
2.5	8	75-85	Simple	\$ 997
3	8	88-94	Simple	\$ 1,068
3	8	95-105	Simple	\$ 1,160
4	8	113-123	Simple	\$ 1,217
6	8	120-131	Simple	\$ 1,255
4	8	126-136	Simple	\$ 1,277
6	8	166-177	Simple	\$ 1,563
6	8	174-184	Simple	\$ 1,592
8	8	202-212	Simple	\$ 1,804
8	8	218-228	Simple	\$ 1,804
8	8	228-239	Simple	\$ 1,804
10	12	246-257	Simple	\$ 2,808
10	12	270-280	Simple	\$ 3,229
10	12	280-291	Simple	\$ 3,399
12	12	310-321	Simple	\$ 3,563
12	12	320-330	Simple	\$ 3,949
12	12	350-360	Simple	\$ 4,483

DIAMETRO	LARGO	RANGO EN MM	PANEL	PRECIO UNITARIO
4	8	113-133	Doble	\$ 1,436
4	8	120-141	Doble	\$ 1,507
8	8	228-249	Doble	\$ 2,142
10	12	273-293	Doble	\$ 3,399
12	12	335-356	Doble	\$ 4,424
14	12	383-403	Doble	\$ 5,572
16	12	436-456	Doble	\$ 6,664
18	12	488-508	Doble	\$ 7,133
20	16	547-567	Doble	\$ 11,689

24	24	625-655	Triple	\$ 13,712
24	24	653-683	Triple	\$ 14,790

30" y 36" Cotizar

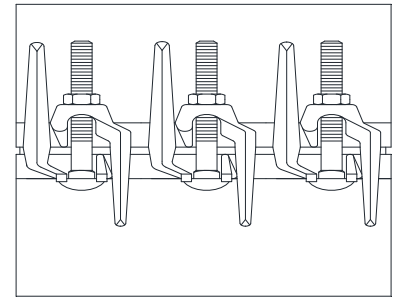

COPLE DE DESMONTAJE

DIMENSION	PRECIO UNITARIO
2	\$ 1,783
3	\$ 2,746
4	\$ 2,816
6	\$ 4,303
8	\$ 5,632
10	\$ 8,449
12	\$ 11,564
14	\$ 14,959
16	\$ 17,543
18	\$ 18,837
20	\$ 22,873
24	\$ 28,725

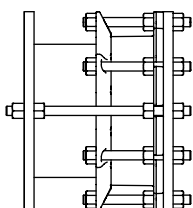

FILTROS "Y"

DIMENSION	PRECIO UNITARIO
2	\$ 1,504
2 ½	\$ 1,943
3	\$ 2,513
4	\$ 3,495
6	\$ 7,057
8	\$ 13,600
10	\$ 21,893
12	\$ 28,296

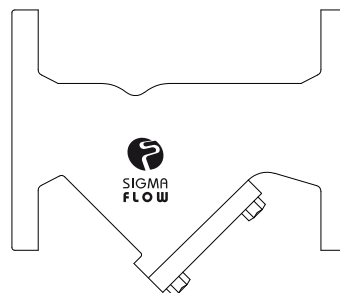

DUO CHECK

DIMENSION	PRECIO UNITARIO
2	\$ 628
2 ½	\$ 770
3	\$ 1,106
4	\$ 1,625
6	\$ 2,498
8	\$ 4,404
10	\$ 7,315
12	\$ 9,980
14	\$ 17,028

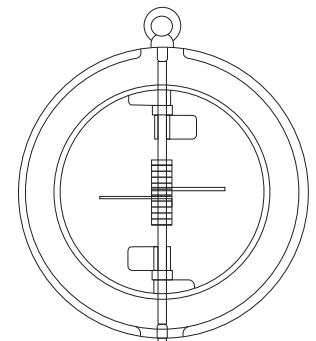

ALCANTARILLADO

DESCRIPCION	PRECIO UNITARIO
BROCAL CON REJILLA DE DUCTIL	\$ 3,569
BROCAL CON REJILLA DE 80 KG.	\$ 3,571
BROCAL CON REJILLA DE 90 KG.	\$ 4,018
BROCAL CON REJILLA DE 110 KG.	\$ 4,911
BROCAL CON REJILLA DE 130 KG.	\$ 5,357
BROCAL CON REJILLA DE 150 KG.	\$ 6,696
BROCAL CON REJILLA DE 160 KG.	\$ 7,143

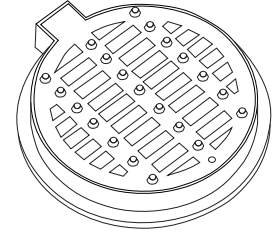

BROCAL CIEGO DE DUCTIL	\$ 3,569
BROCAL CIEGO DE 85 KG	\$ 3,571
BROCAL CIEGO DE 95 KG	\$ 4,018
BROCAL CIEGO DE 115 KG	\$ 4,911
BROCAL CIEGO DE 135 KG	\$ 5,804
BROCAL CIEGO DE 160 KG	\$ 7,143

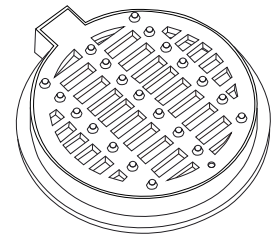

MARCO CON TAPA AP 50 X 50 CM DUCTIL	\$ 3,209
MARCO CON TAPA 70 X 70 SADM DUCTIL	\$ 10,310
MARCO CON TAPA AP 50 X 50 CM DE 67 KG	\$ 2,976
MARCO CON TAPA AP 50 X 50 CM DE 80 KG	\$ 3,434
MARCO CON TAPA AP 50 X 50 CM DE 110 KG	\$ 4,688
MARCO CON TAPA AP 50 X 50 CM DE 130 KG	\$ 5,357

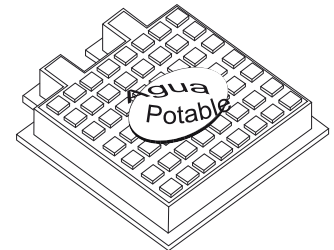

CAJA PARA LLAVE DE BANQUETA (BOTA LARGA)	\$ 273
CAJA PARA LLAVE DE BANQUETA (BOTA CORTA)	\$ 183
ESCALON PARA POZO DE VISITA LIGERO	\$ 141
ESCALON PARA POZO DE VISITA PESADO	\$ 212
COLADERA PLUVIAL	\$ 3,434
PLATO ROMPECHORRO COMPLETO	\$ 2,412
REGISTRO PARA VALVULA TELESCOPICO DE 61 A 92 CM.	\$ 2,630
REGISTRO PARA VALVULA TELESCOPICO DE 92 A 122 CM.	\$ 3,262

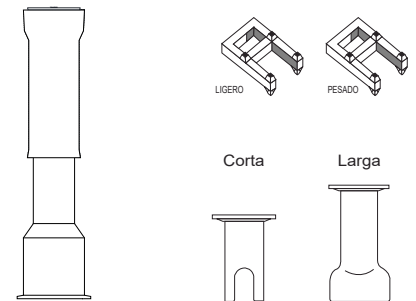

ARO Y TAPA CFE 84-B DE 105 KG	\$ 5,652
ARO Y TAPA CFE 84-B DE 120 KG	\$ 6,460
ARO Y TAPA CFE 84-B DE 135 KG	\$ 7,267
ARO Y TAPA CFE 84-B DE 110 KG CON BISAGRA	\$ 5,921
ARO Y TAPA CFE 84-B DE 125 KG CON BISAGRA	\$ 6,729
ARO Y TAPA CFE 84-B DE 140 KG CON BISAGRA	\$ 7,536

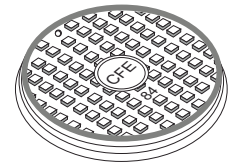

MARCO TAPA CFE 84-A DE 150 KG	\$ 8,075
MARCO TAPA CFE 84-A DE 180 KG	\$ 9,689
MARCO Y TAPA CFE 84-A DE 190 KG CON BISAGRA	\$ 10,228
MARCO Y TAPA REFORZADO CFE 84-A DE 250 KG	\$ 13,458
MARCO Y TAPA REFORZADO CFE 84-A DE 250 KG C/ BISAGRA	\$ 13,458

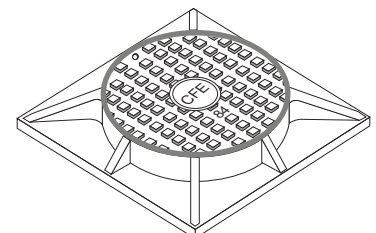

***** PRECIOS SUJETOS A CAMBIOS SIN PREVIO AVISO

CONTRAMARCOS

DIMENSION	CENTRADO O DESCENT.	
	SENCILLO	DOBLE
4" x 0.90	\$ 2,588	
4" x 1.00	\$ 2,720	
4" x 1.10	\$ 2,874	
4" x 1.20	\$ 3,017	
4" x 1.30	\$ 3,168	
4" x 1.40	\$ 3,308	\$ 4,277
4" x 1.50	\$ 3,447	\$ 4,420
4" x 1.60	\$ 3,613	\$ 4,611
4" x 1.70	\$ 3,764	\$ 4,762
4" x 1.80	\$ 3,901	\$ 4,899
4" x 1.90	\$ 4,043	\$ 5,072
4" x 2.00	\$ 4,217	\$ 5,267
4" x 2.10	\$ 4,356	\$ 5,410

DIMENSION	CENTRADO O DESCENT.	
	SENCILLO	DOBLE
6" x 1.30	\$ 4,876	
6" x 1.40	\$ 5,089	
6" x 1.50	\$ 5,304	\$ 6,841
6" x 1.60	\$ 5,621	\$ 7,203
6" x 1.70	\$ 5,830	\$ 7,422
6" x 1.80	\$ 6,050	\$ 7,634
6" x 1.90	\$ 6,275	\$ 7,791
6" x 2.00	\$ 6,530	\$ 8,116
6" x 2.10	\$ 6,749	\$ 8,337
6" x 2.20	\$ 6,967	\$ 8,553
6" x 2.30	\$ 7,741	\$ 8,772
6" x 2.40	\$ 8,133	\$ 8,977

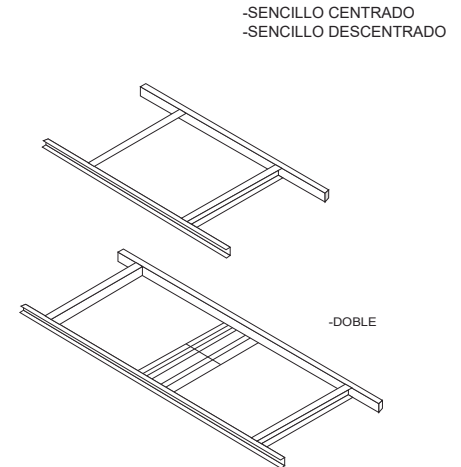

ALCANTARILLADO POLIETILENO

DESCRIPCION	PRECIO UNITARIO
BROCAL CIEGO POLIETILENO MEDIA DENSIDAD	Cotizar
BROCAL CON REJILLA POLIETILENO MEDIA DENSIDAD	Cotizar
BROCAL CIEGO POLIETILENO HALO EXTENDIDO	Cotizar
MARCO CON TAPA AP 50 X 50 CM POLIETILENO	Cotizar

JUNTAS TIPO DRESER

DISPONIBLES DE 2" A 48"
COTIZAR DE ACUERDO A DIAMETRO EXTERIOR DE TUBERIA