



SIGMA™



SIMEX

Conexiones Compactas de Junta Mecanica



CONEXIONES COMPACTAS DE JUNTA MECANICA

Indice

Especificaciones Técnicas	1
Codos MJ x MJ	2
Codos MJ x Brida, Adaptadores MJ x Brida, Cruz MJ x MJ	3
Tee MJ x MJ, Tee MJ x Brida	4
Tee y Cruz con Rosca, Tapa Ciega Hembra (Cap) y Macho (Plug), Tapa de Empuje, Laterales de 45°	6
Reducciones	7
Tee MJ x Eslabón Giratorio, Adaptadores: Salida Eslabón giratorio, Cotrabrida Swivel, Tee Reductoras, Codos con Eslabón Giratorio	8
Desviaciones, Carretes, Carretes MJ x Espiga	9
Contra Brida Estándar, Empaques, Contrabridas de Retención	10
Paquete Contrabrida, Paquete Brida de Transición, Paquete Contra Brida de Retención, Tornillos Cabeza "T", Paquete de Tornillos	11
One - Lok	12
PV - Lok	13

ESPECIFICACIONES TECNICAS CONEXIONES COMPACTAS DE JUNTA MECANICA

MATERIALES:	Hierro Dúctil ASTM A536 Grado 65-45-12
RANGOS DE PRESION:	Presión de trabajo en agua 350 PSI (3" - 24") y 250 PSI (30"-48")
PRUEBAS:	De acuerdo con ANSI / AWWA C153 / A21.53 y los requeridos por UL y FM
DIMENSIONES:	La sección recto del cuerpo fue eliminada para proveer en una conexión compacta y de bajo peso sin reducir su resistencia o características de flujo, en acuerdo con ANSI / AWWA C153 / A21.53 (3" a 48")
REVESTIMIENTO DE CEMENTO:	En acuerdo con ANSI / AWWA C104 / A21.4
RECUBRIMIENTO EXTERIOR E INTERIOR:	Pintura Bituminosa por dentro y fuera en acuerdo con ANSI / AWWA C104 / A21.4
EMPAQUES:	SBR en acuerdo con ANSI / AWWA C111 / A21.11
TORNILLOS "T":	Acero de baja aleación de alta resistencia con recubrimiento resistente a corrosión en acuerdo a ANSI / AWWA C111 / A21.11
CERTIFICACIONES:	Listado en Underwriters Laboratories (UL) y aprobado por Factory Mutual (FM), NSF 61.
ESTANDARES:	ANSI / AWWA C153 / A21.53 para conexiones compactas de Hierro Dúctil de 3" a 48" para agua y otros líquidos. (30" y 36" para espesor de tubería clase 56)

DETALLES DE LA JUNTA MECANICA

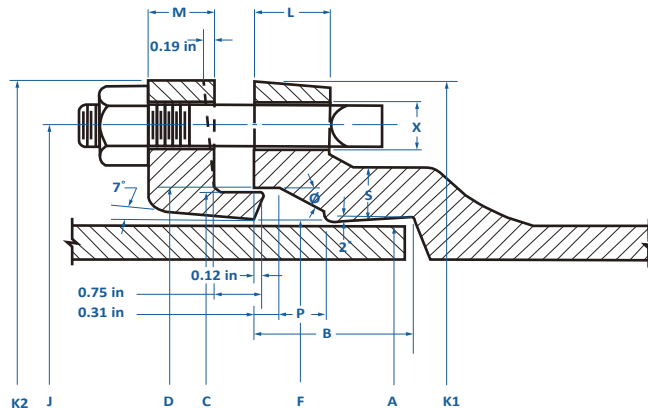

DETALLES DE ESPIGA

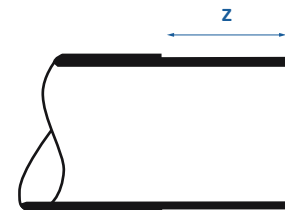

Diámetro	A	B	C	D	F	J	K1	K2	L	M	P	S	X	Z	TONILLOS		
															No. Piezas	Diametro	Largo
3	3.96	2.50	4.84	4.94	4.06	6.19	7.62	7.69	0.58	0.62	0.63	0.39	3/4	5.50	4.00	5/8	3.00
4	4.80	2.50	5.92	6.02	4.90	7.50	9.06	9.12	0.60	0.75	0.75	0.39	7/8	5.50	4.00	3/4	3.50
6	6.90	2.50	8.02	8.12	7.00	9.50	11.06	11.12	0.63	0.88	0.75	0.43	7/8	5.50	6.00	3/4	3.50
8	9.05	2.50	10.17	10.27	9.15	11.75	13.31	13.37	0.66	1.00	0.75	0.45	7/8	5.50	6.00	3/4	3.50
10	11.10	2.50	12.22	12.34	11.20	14.00	15.62	15.62	0.70	1.00	0.75	0.47	7/8	5.50	8.00	3/4	3.50
12	13.20	2.50	14.32	14.44	13.30	16.25	17.88	17.88	0.73	1.00	0.75	0.49	7/8	5.50	8.00	3/4	3.50
14	15.30	3.50	16.40	16.54	15.44	18.75	20.25	20.25	0.79	1.25	0.75	0.55	7/8	8.00	10.00	3/4	4.00
16	17.40	3.50	18.50	18.64	17.54	21.00	22.50	22.50	0.85	1.31	0.75	0.58	7/8	8.00	12.00	3/4	4.00
18	19.50	3.50	20.60	20.74	19.64	23.25	24.83	24.75	1.00	1.38	0.75	0.68	7/8	8.00	12.00	3/4	4.00
20	21.60	3.50	22.70	22.84	21.74	25.50	27.08	27.00	1.02	1.44	0.75	0.69	7/8	8.00	14.00	3/4	4.00
24	25.80	3.50	26.90	27.04	25.94	30.00	31.58	31.50	1.02	1.56	1.00	0.75	7/8	8.00	16.00	3/4	4.50
30	32.00	4.00	33.29	33.46	32.17	36.88	39.12	39.12	1.31	2.00	1.00	0.82	1 1/8	8.00	20.00	1	5.50
36	38.30	4.00	39.59	39.76	38.47	43.75	46.00	46.00	1.45	2.00	1.00	1.00	1 1/8	8.00	24.00	1	5.50
42	44.50	4.00	45.79	45.96	44.67	50.62	53.12	53.12	1.45	2.00	1.00	1.25	1 3/8	8.00	28.00	1 1/4	6.00
48	50.80	4.00	52.09	52.26	50.97	57.50	60.00	60.00	1.45	2.00	1.00	1.35	1 3/8	8.00	32.00	1 1/4	6.00

DIMENSIONES EN PULGADAS

CONEXIONES COMPACTAS DE JUNTA MECANICA (MJ) HIERRO DUCTIL CLASE 350 DE ACUERDO A ANSI / AWWA C153 / A21.53

CODOS 90°

Diámetro	MJ X MJ			MJ X PE				T
	No. de Parte	Peso	A	No. de Parte	Peso	A	B	
2	DMB290	17	3.00					0.30
3	DMB390	19	3.50	DME390	16	3.25	8.50	0.33
4	DMB490	25	4.00	DME490	22	4.00	9.50	0.34
6	DMB690	39	5.00	DME690	41	5.00	11.50	0.36
8	DMB890	57	6.50	DME890	58	6.50	12.50	0.38
10	DMB1090	89	7.50	DME1090	88	7.50	13.00	0.40
12	DMB1290	108	9.00	DME1290	114	9.00	14.50	0.42
14	DMB1490	210	11.50	DME1490	211	11.50	19.50	0.47
16	DMB1690	264	12.50	DME1690	248	12.50	20.50	0.50
18	DMB1890	335	14.00	DME1890	325	14.00	21.00	0.54
20	DMB2090	400	15.00	DME2090	390	15.00	22.50	0.57
24	DMB2490	565	16.75	DME2490	575	17.00	25.00	0.61
30	DMB3090	930	25.50	DME3090	865	21.50	30.50	0.66
36	DMB3690	1450	24.50	DME3690	1355	24.50	33.50	0.74
42	DMB4290	2205	29.25	DME4290	2055	29.25	38.25	0.82
48	DMB4890	2990	33.25	DME4890	2805	33.25	42.25	0.90

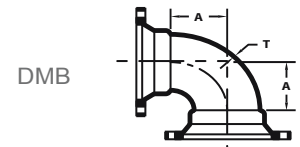

MJ x MJ 90°

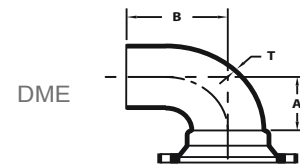

MJ x PE 90°

CODOS 45°

Diámetro	MJ X MJ			MJ X PE				T
	No. de Parte	Peso	A	No. de Parte	Peso	A	B	
2	DMB245	10	1.50					0.30
3	DMB345	16	1.50	DME345	13	1.50	7.00	0.33
4	DMB445	22	2.00	DME445	19	2.00	7.50	0.34
6	DMB645	32	3.00	DME645	34	3.00	8.50	0.36
8	DMB845	46	3.50	DME845	49	3.50	9.00	0.38
10	DMB1045	70	4.50	DME1045	70	4.50	10.00	0.40
12	DMB1245	86	5.50	DME1245	93	5.50	11.00	0.42
14	DMB1445	160	5.00	DME1445	146	5.00	13.00	0.47
16	DMB1645	202	5.50	DME1645	212	5.50	13.50	0.50
18	DMB1845	250	6.00	DME1845	235	6.00	13.00	0.54
20	DMB2045	305	7.00	DME2045	290	7.00	14.00	0.57
24	DMB2445	405	7.50	DME2445	390	7.50	14.50	0.61
30	DMB3045	780	10.50	DME3045	715	10.50	19.50	0.66
36	DMB3645	1135	11.50	DME3645	1040	12.00	21.00	0.74
42	DMB4245	1610	14.00	DME4245	1460	14.00	23.00	0.82
48	DMB4845	2090	15.00	DME4845	1905	15.00	24.00	0.90

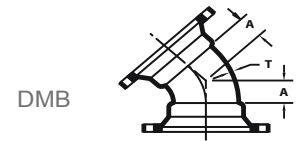

MJ x MJ 45°

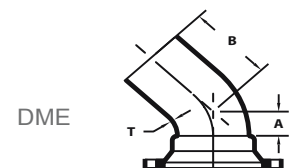

MJ x PE 45°

CODOS 22 1/2°

Diámetro	MJ X MJ			MJ X PE				T
	No. de Parte	Peso	A	No. de Parte	Peso	A	B	
3	DMB322	15	1.00	DME322	12	1.00	6.50	0.33
4	DMB422	18	1.50	DME422	18	1.50	7.00	0.34
6	DMB622	31	2.00	DME622	29	2.00	7.50	0.36
8	DMB822	46	2.50	DME822	43	2.50	8.00	0.38
10	DMB1022	64	3.00	DME1022	61	3.00	8.50	0.40
12	DMB1222	80	3.50	DME1222	79	3.50	9.00	0.42
14	DMB1422	136	3.75	DME1422	133	3.75	11.25	0.47
16	DMB1622	172	3.75	DME1622	166	3.75	11.75	0.50
18	DMB1822	255	4.50	DME1822	235	6.00	13.00	0.54
20	DMB2022	310	4.50	DME2022	300	7.00	14.00	0.57
24	DMB2422	412	4.50	DME2422	395	7.50	14.50	0.61
30	DMB3022	665	6.75	DME3022	600	6.75	15.75	0.66
36	DMB3622	960	7.75	DME3622	865	7.75	16.75	0.74
42	DMB4222	1350	9.00	DME4222	1200	9.00	18.00	0.82
48	DMB4822	1760	10.00	DME4822	1575	10.00	19.00	0.90

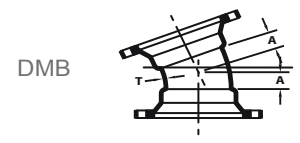

MJ x MJ 22 1/2°

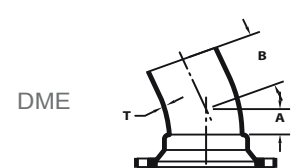

MJ x PE 22 1/2°

CODOS 11 1/4°

Diámetro	MJ X MJ			MJ X PE				T
	No. de Parte	Peso	A	No. de Parte	Peso	A	B	
3	DMB311	14	1.00	DME311	12	1.00	6.50	0.33
4	DMB411	16	1.25	DME411	17	1.25	6.25	0.34
6	DMB611	30	1.50	DME611	27	1.50	7.00	0.36
8	DMB811	42	1.75	DME811	39	1.75	7.25	0.38
10	DMB1011	58	2.00	DME1011	52	2.00	7.50	0.40
12	DMB1211	67	2.25	DME1211	69	2.25	7.75	0.42
14	DMB1411	93	2.50	DME1411	118	2.50	10.50	0.47
16	DMB1611	148	2.50	DME1611	136	2.50	10.50	0.50
18	DMB1811	205	3.00	DME1811	235	6.00	13.00	0.54
20	DMB2011	245	3.00	DME2011	300	7.00	14.00	0.57
24	DMB2411	315	3.00	DME2411	400	7.50	14.50	0.61
30	DMB3011	600	4.75	DME3011	535	4.75	13.75	0.66
36	DMB3611	820	5.00	DME3611	725	5.00	14.00	0.74
42	DMB4211	1180	6.00	DME4211	1030	6.00	15.00	0.82
48	DMB4811	1475	6.50	DME4811	1290	6.50	15.50	0.90

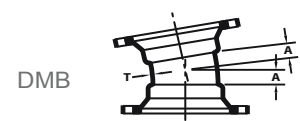

MJ x MJ 11 1/4°

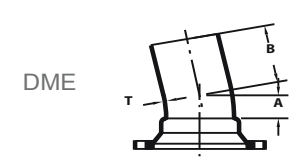

MJ x PE 11 1/4°

CONEXIONES COMPACTAS DE JUNTA MECANICA (MJ) HIERRO DUCTIL CLASE 350 DE ACUERDO A ANSI / AWWA C153 / A21.53

TEES

Diámetro	MJ X MJ				T	T1	MJ X BRIDA			
	No. de Parte	Peso	H	J			No. de Parte	Peso	H	L
2 x 2	DMT22	16	3.00	3.00	0.30	0.30				
3 x 3	DMT33	28	3.00	3.00	0.33	0.33	DMF33	28	3.00	5.50
4 x 2	DMT42	29	3.00	4.00	0.34	0.30				
4 x 3	DMT43	30	3.50	4.00	0.34	0.33	DMF43	30	3.5	6.50
4 x 4	DMT44	32	4.00	4.00	0.34	0.34	DMF44	38	4.00	6.50
6 x 3	DMT63	42	3.50	5.00	0.36	0.33	DMF63	51	3.50	8.00
6 x 4	DMT64	46	4.00	5.00	0.36	0.34	DMF64	54	4.00	8.00
6 x 6	DMT66	56	5.00	5.00	0.36	0.36	DMF66	56	5.00	8.00
8 x 3	DMT83	52	3.50	6.50	0.38	0.33	DMF83	70	4.00	9.00
8 x 4	DMT84	60	4.00	6.50	0.38	0.34	DMF84	72	4.00	9.00
8 x 6	DMT86	72	5.00	6.50	0.38	0.36	DMF86	83	5.00	9.00
8 x 8	DMT88	86	6.50	6.50	0.80	0.38	DMF88	94	6.50	9.00
10 x 3	DMT103	75	4.00	7.50	0.40	0.33				
10 x 4	DMT104	78	4.00	7.50	0.40	0.34	DMF104	89	4.00	11.00
10 x 6	DMT106	90	5.00	7.50	0.40	0.36	DMF106	107	5.00	11.00
10 x 8	DMT108	105	6.50	7.50	0.40	0.38	DMF108	115	6.50	11.00
10 x 10	DMT1010	120	7.50	7.50	0.40	0.40	DMF1010	130	7.50	11.00
12 x 3	DMT123	90	4.00	8.75	0.42	0.33				
12 x 4	DMT124	94	4.00	8.75	0.42	0.34	DMF124	115	4.00	12.00
12 x 6	DMT126	110	5.00	8.75	0.42	0.36	DMF126	120	5.00	12.00
12 x 8	DMT128	125	6.50	8.75	0.42	0.38	DMF128	146	6.50	12.00
12 x 10	DMT1210	140	7.50	8.75	0.42	0.40	DMF1210	174	7.50	12.00
12 x 12	DMT1212	160	8.75	8.75	0.42	0.42	DMF1212	198	8.75	12.00
14 x 3	DMT143	x	5.50	10.50	0.57	0.33				
14 x 4	DMT144	172	5.50	10.50	0.47	0.34	DMF144	161	5.50	14.00
14 x 6	DMT146	182	6.50	10.50	0.47	0.36	DMF146	177	6.50	14.00
14 x 8	DMT148	206	7.50	10.50	0.47	0.38	DMF148	199	7.50	14.00
14 x 10	DMT1410	228	8.50	10.50	0.47	0.40				
14 x 12	DMT1412	234	9.50	10.50	0.47	0.42	DMF1412	276	9.50	14.00
14 x 14	DMT1414	280	10.50	10.50	0.47	0.47	DMF1414	277	10.50	14.00
16 x 3	DMT163	x	6.50	11.50	0.50	0.33				
16 x 6	DMT166	228	6.50	11.50	0.50	0.36	DMF166	213	6.50	15.00
16 x 8	DMT168	248	7.50	11.50	0.50	0.38	DMF168	260	7.50	15.00
16 x 10	DMT1610	264	8.50	11.50	0.50	0.40	DMF1610	287	8.50	15.00
16 x 12	DMT1612	280	9.50	11.50	0.50	0.42	DMF1612	312	9.50	15.00
16 x 14	DMT1614	316	10.50	11.50	0.50	0.47	DMF1614	360	10.50	15.00
16 x 16	DMT1616	322	11.50	11.50	0.50	0.50	DMF1616	374	11.50	15.00

MJ x MJ
DMT

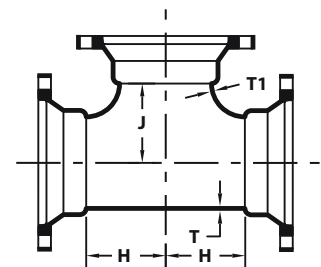

MJ x BRIDA
DMF

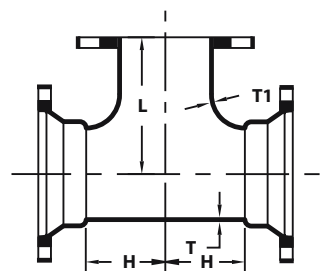

PESOS EN LIBRAS
DIMENSIONES EN PULGADAS
TODOS LOS PESOS MOSTRADOS SON SIN ACCESORIOS

CONEXIONES COMPACTAS DE JUNTA MECANICA (MJ) HIERRO DUCTIL CLASE 350 DE ACUERDO A ANSI / AWWA C153 / A21.53

TEES

Diámetro	MJ X MJ						MJ X BRIDA			
	No. de Parte	Peso	H	J	T	T1	No. de Parte	Peso	H	L
18 x 6	DMT186	275	6.50	12.50	0.54	0.37	DMF186	321	6.50	15.50
18 x 8	DMT188	295	7.50	12.50	0.54	0.38	DMF188	340	7.50	15.50
18 x 10	DMT1810	315	8.50	12.50	0.54	0.40	DMF1810	x	8.50	15.50
18 x 12	DMT1812	335	9.50	12.50	0.54	0.42	DMF1812	x	9.50	15.50
18 x 14	DMT1814	380	10.50	12.50	0.54	0.47	DMF1814	x	10.50	16.50
18 x 16	DMT1816	428	11.50	12.50	0.54	0.50	DMF1816	440	11.50	16.50
18 x 18	DMT1818	448	12.50	12.50	0.54	0.54	DMF1818	445	12.50	16.50
20 x 6	DMT206	348	6.50	14.00	0.57	0.36	DMF206	345	6.50	17.00
20 x 8	DMT208	345	8.00	14.00	0.57	0.39	DMF208	384	8.00	17.00
20 x 10	DMT2010	370	9.00	14.00	0.57	0.40	DMF2010	367	9.00	17.00
20 x 12	DMT2012	441	10.00	14.00	0.57	0.42	DMF2012	402	10.00	17.00
20 x 14	DMT2014	440	11.00	14.00	0.57	0.47	DMF2014	435	11.00	17.00
20 x 16	DMT2016	465	12.00	14.00	0.57	0.50	DMF2016	477	12.00	18.00
20 x 18	DMT2018	505	13.00	14.00	0.57	0.54	DMF2018	507	13.00	18.00
20 x 20	DMT2020	535	14.00	14.00	0.57	0.57	DMF2020	554	14.00	18.00
24 x 6	DMT246	415	7.00	16.00	0.61	0.36	DMF246	460	7.00	19.00
24 x 8	DMT248	445	8.00	16.00	0.61	0.38	DMF248	418	8.00	19.00
24 x 10	DMT2410	470	9.00	16.00	0.61	0.40	DMF2410	462	9.00	19.00
24 x 12	DMT2412	500	10.00	16.00	0.61	0.42	DMF2412	502	10.00	19.00
24 x 14	DMT2414	550	11.00	16.00	0.61	0.47	DMF2414	539	11.00	19.00
24 x 16	DMT2416	580	12.00	16.00	0.61	0.50	DMF2416	579	12.00	19.00
24 x 18	DMT2418	630	13.00	16.00	0.61	0.54	DMF2418	634	13.00	22.00
24 x 20	DMT2420	660	14.00	16.00	0.61	0.57	DMF2420	686	14.00	22.00
24 x 24	DMT2424	720	16.00	16.00	0.61	0.61	DMF2424	789	16.00	22.00
30 x 6	DMT306	700	7.00	20.00	0.66	0.36	DMF306	1000	8.50	23.00
30 x 8	DMT308	739	8.50	20.00	0.66	0.38	DMF308	x	8.50	23.00
29 x 10	DMT2910	785	10.00	20.00	0.66	0.40				
30 x 12	DMT3012	830	10.00	20.00	0.66	0.43	DMF3012	x	10.00	23.00
30 x 16	DMT3016	959	12.50	20.00	0.66	0.50	DMF3016	1035	12.5	23.00
30 x 18	DMT3018	1085	13.00	20.00	0.66	0.54				
30 x 20	DMT3020	995	15.00	20.00	0.66	0.57	DMF3020	x	15.00	23.00
30 x 24	DMT3024	1060	16.00	20.00	0.66	0.61	DMF3024	x	16.00	23.00
30 x 30	DMT3030	1323	20.00	20.00	0.66	0.66	DMF3030	1267	20.00	23.00
36 x 6	DMT366	1025	8.00	23.50	0.74	0.36				
36 x 8	DMT368	1091	9.00	23.50	0.74	0.38				
36 x 10	DMT3610	1184	10.00	23.50	0.74	0.40				
36 x 12	DMT3612	1205	10.00	23.50	0.74	0.43	DMF3612	1034	10.00	26.00
36 x 14	DMT3614	1112	12.50	23.50	0.74	0.47				
36 x 16	DMT3616	1350	12.50	23.50	0.74	0.52				
36 x 18	DMT3618	1155	13.00	23.50	0.74	0.54	DMF3618	1307	16.00	26.00
36 x 20	DMT3620	1240	15.00	23.50	0.74	0.57				
36 x 24	DMT3624	1498	16.00	23.50	0.74	0.61	DMF3624	1930	16.00	26.00
36 x 30	DMT3630	1555	20.00	23.50	0.74	0.66	DMF3630	1937	20.00	28.00
36 x 36	DMT3636	1900	23.50	23.50	0.74	0.74	DMF3636	1924	23.00	28.00
42 x 6	DMT416	1343	10.00	27.50	0.82	0.36				
42 x 8	DMT418	1347	10.00	27.50	0.82	0.38				
42 x 12	DMT4212	1410	10.00	29.50	0.82	0.43				
42 x 16	DMT4216	1502	12.50	27.50	0.82	0.50				
42 x 18	DMT4218	2000	16.00	27.50	0.82	0.54				
42 x 20	DMT4220	2433	20.00	27.50	0.82	0.57				
42 x 24	DMT4224	2270	20.00	27.50	0.82	0.61	DMF4224	x	20.00	30.00
42 x 30	DMT4230	2425	22.00	29.50	0.82	0.66	DMF4230	3132	22.00	31.00
42 x 36	DMT4236	3000	30.00	30.00	0.82	0.74	DMF4236	2765	30.00	31.00
42 x 42	DMT4242	3175	30.00	30.00	0.82	0.82	DMF4242	x	30.00	31.00
48 x 6	DMT486	1685	10.00	32.00	0.90	0.36				
48 x 8	DMT488	1692	10.00	32.00	0.90	0.38				
48 x 12	DMT4812	2030	15.00	32.00	0.90	0.42				
48 x 16	DMT4816	2393	20.00	32.00	0.90	0.50				
48 x 18	DMT4818	2345	16.00	32.00	0.90	0.54				
48 x 20	DMT4820	2500	20.00	32.00	0.90	0.57				
48 x 24	DMT4824	2870	23.00	32.00	0.90	0.61	DMF4824	x	23.00	34.00
48 x 30	DMT4830	3050	23.00	32.00	0.90	0.66	DMF4830	2762	23.00	34.00
48 x 36	DMT4836	3900	33.50	32.25	0.90	0.74	DMF4836	3594	33.50	34.00
48 x 42	DMT4842	4100	33.50	33.50	0.90	0.82	DMF4842	3739	33.50	34.00
48 x 48	DMT4848	4250	33.50	33.50	0.90	0.90	DMF4848	3878	33.50	34.00

MJ x MJ
DMT

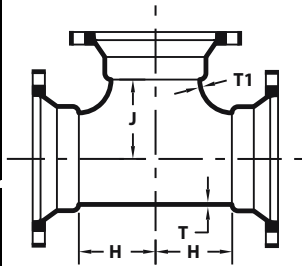

MJ x BRIDA
DMF

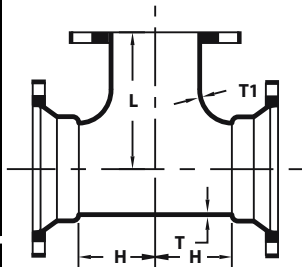

PESOS EN LIBRAS
DIMENSIONES EN PULGADAS
TODOS LOS PESOS MOSTRADOS SON SIN ACCESORIOS

**CONEXIONES COMPACTAS DE JUNTA MECANICA (MJ)
HIERRO DUCTIL CLASE 350 DE ACUERDO A ANSI / AWWA C153 / A21.53**

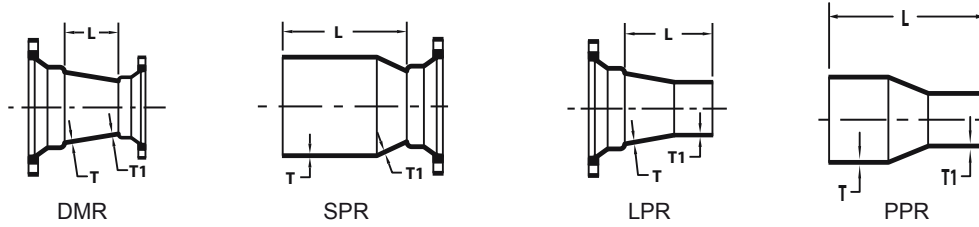

REDUCCIONES

Diámetro	MJ X MJ			ESPIGA X MJ (MJ CORTA)			MJ X ESPIGA (MJ LARGA)			ESPIGA X ESPIGA			T	T1
	No. de Parte	Peso	L	No. de Parte	Peso	L1	No. de Parte	Peso	L2	No. de Parte	Peso	L3		
3 x 2	DMR32	14	2.5										0.33	0.30
4 x 2	DMR42	16	2.50	SPR42	14	8.00							0.34	0.30
4 x 3	DMR43	18	3.00	SPR43	17	8.50	LPR43	18	8.50	PPR43	14	14.00	0.34	0.33
6 x 3	DMR63	22	5.00	SPR63	24	10.50	LPR63	19	10.50	PPR63	19	16.00	0.36	0.33
6 x 4	DMR64	24	4.00	SPR64	25	9.50	LPR64	25	9.50	PPR64	22	15.00	0.36	0.34
8 X 3	DMR83	30	5.00										0.38	0.33
8 x 4	DMR84	32	5.00	SPR84	30	10.50	LPR84	34	10.50	PPR84	30	16.00	0.38	0.34
8 x 6	DMR86	36	4.00	SPR86	35	9.50	LPR86	32	9.50	PPR86	30	15.00	0.38	0.36
10 x 4	DMR104	46	7.00	SPR104	43	12.50	LPR104	43	12.50	PPR104	46	18.00	0.40	0.34
10 x 6	DMR106	47	5.00	SPR106	46	10.50	LPR106	42	10.50	PPR106	46	16.00	0.40	0.36
10 x 8	DMR108	50	4.00	SPR108	42	9.50	LPR108	50	9.50	PPR108	49	15.00	0.40	0.38
12 x 4	DMR124	58	9.00	SPR124	60	14.50	LPR124	60	14.50	PPR124	58	20.00	0.42	0.34
12 x 6	DMR126	58	7.00	SPR126	58	12.50	LPR126	58	12.50	PPR126	58	18.00	0.42	0.36
12 x 8	DMR128	57	5.00	SPR128	54	10.50	LPR128	55	10.50	PPR128	59	16.00	0.42	0.38
12 x10	DMR1210	61	4.00	SPR1210	59	9.50	LPR1210	59	9.50	PPR1210	59	15.00	0.42	0.40
14 x 6	DMR146	100	9.00	SPR146	100	16.90	LPR146	104	14.50	PPR146	93	22.30	0.47	0.36
14 x 8	DMR148	100	7.00	SPR148	98	14.90	LPR148	98	12.40	PPR148	94	20.30	0.47	0.38
14 x 10	DMR1410	100	5.00	SPR1410	94	12.90	LPR1410	92	10.40	PPR1410	90	18.30	0.47	0.40
14 x 12	DMR1412	100	4.00	SPR1412	90	11.90	LPR1412	92	9.40	PPR1412	88	17.30	0.47	0.42
16 x 6	DMR166	124	11.00	SPR166	125	18.90	LPR166	136	16.50	PPR166	93	24.00	0.50	0.36
16 x 8	DMR168	124	9.00	SPR168	121	16.90	LPR168	128	14.40	PPR168	121	22.30	0.50	0.38
16 x 10	DMR1610	124	7.00	SPR1610	105	15.00	LPR1610	123	12.50	PPR1610	119	20.50	0.50	0.40
16 x 12	DMR1612	112	5.00	SPR1612	109	12.90	LPR1612	108	10.50	PPR1612	99	18.30	0.50	0.42
16 x 14	DMR1614	140	4.00	SPR1614	126	12.00	LPR1614	132	12.00	PPR1614	129	19.70	0.50	0.47
18 X 4	DMR184	170	11.00										0.54	0.34
18 x 6	DMR186	194	16.00										0.54	0.36
18 x 8	DMR188	190	13.00	SPR188	170	20.00	LPR188	195	19.50	PPR188	170	27.40	0.54	0.38
18 x 10	DMR1810	195	10.00	SPR1810	165	18.00	LPR1810	185	17.40	PPR1810	160	25.50	0.54	0.40
18 x 12	DMR1812	180	7.00	SPR1812	150	15.50	LPR1812	175	14.00	PPR1812	150	19.50	0.54	0.42
18 x 14	DMR1814	190	6.00	SPR1814	175	15.00	LPR1814	190	15.00	PPR1814	160	23.00	0.54	0.47
18 x 16	DMR1816	193	5.00	SPR1816	170	12.50	LPR1816	190	12.50	PPR1816	145	18.00	0.54	0.50
20 x 6	DMR206	232	22.00	SPR206	201	30.00	LPR206	231	27.50	PPR206	106	35.50	0.57	0.36
20 x 8	DMR208	227	19.00	SPR208	198	27.00	LPR208	227	24.50	PPR208	106	32.50	0.57	0.38
20 x 10	DMR2010	230	14.00	SPR2010	200	22.00	LPR2010	210	19.00	PPR2010	180	27.50	0.57	0.40
20 x 12	DMR2012	205	12.00	SPR2012	170	17.50	LPR2012	205	16.00	PPR2012	190	21.50	0.57	0.42
20 x 14	DMR2014	200	10.00	SPR2014	190	18.00	LPR2014	205	17.90	PPR2014	195	26.00	0.57	0.47
20 x 16	DMR2016	200	7.00	SPR2016	185	13.50	LPR2016	200	13.50	PPR2016	170	19.00	0.57	0.50
20 x 18	DMR2018	225	4.00	SPR2018	200	12.00	LPR2018	225	12.00	PPR2018	190	20.00	0.57	0.54
24 x 6	DMR246	322	28.00	SPR246	284	36.00	LPR246	320	33.50	PPR246	283	41.50	0.61	0.36
24 x 8	DMR248	318	25.00	SPR248	282	33.00	LPR248	316	30.50	PPR248	281	38.50	0.61	0.38
24 x 10	DMR2410	312	22.00	SPR2410	276	30.00	LPR2410	310	27.50	PPR2410	274	35.50	0.61	0.40
24 x 12	DMR2412	305	16.00	SPR2412	275	21.50	LPR2412	290	21.00	PPR2412	240	22.50	0.61	0.42
24 x 14	DMR2414	310	14.00	SPR2414	310	22.00	LPR2414	315	21.90	PPR2414	295	25.00	0.61	0.47
24 x 16	DMR2416	320	12.00	SPR2416	285	17.50	LPR2416	285	17.50	PPR2416	285	23.00	0.61	0.50
24 x 18	DMR2418	308	10.00	SPR2418	300	18.00	LPR2418	310	18.00	PPR2418	290	21.00	0.61	0.54
24 x 20	DMR2420	300	7.00	SPR2420	270	13.50	LPR2420	275	13.50	PPR2420	240	14.00	0.61	0.57
30 x 12	DMR3012	499	30.00										0.66	0.42
30 x 16	DMR3016	633	30.00	SPR3016	565	39.00	LPR3016	623	39.00	PPR3016	555	48.00	0.66	0.50
30 x 18	DMR3018	658	28.00	SPR3018	590	37.00	LPR3018	635	37.00	PPR3018	567	46.00	0.66	0.54
30 x 20	DMR3020	628	24.00	SPR3020	560	33.00	LPR3020	603	33.00	PPR3020	535	42.00	0.60	0.57
30 x 24	DMR3024	478	10.00	SPR3024	495	24.50	LPR3024	526	24.50	PPR3024	458	3.50	0.66	0.61
36 x 12	DMR3612	678	30.00										0.74	0.42
36 x 16	DMR3616	1078	30.00										0.74	0.50
36 x 18	DMR3618	876	36.00										0.74	0.54
36 x 20	DMR3620	975	36.00	SPR3620	874	45.00	LPR3620	950	45.00	PPR3620	849	54.00	0.74	0.57
36 x 24	DMR3624	770	19.00	SPR3624	746	33.00	LPR3624	810	33.00	PPR3624	709	42.00	0.74	0.61
36 x 30	DMR3630	650	15.00	SPR3630	725	24.50	LPR3630	758	24.50	PPR3630	657	33.50	0.74	0.66
42 x 20	DMR4220	1208	40.00										0.82	0.57
42 x 24	DMR4224	1356	40.00	SPR4224	1204	49.00	LPR4224	1319	49.00	PPR4224	1167	58.00	0.82	0.61
42 x 30	DMR4230	1083	20.00	SPR4230	931	29.00	LPR4230	1015	29.00	PPR4230	863	38.00	0.82	0.66
42 x 36	DMR4236	1114	15.50	SPR4236	962	24.50	LPR4236	1013	24.50	PPR4236	861	33.50	0.82	0.74
48 x 20	DMR4820	1462	40.00										0.90	0.57
48 x 24	DMR4824	1700	40.00										0.90	0.61
48 x 30	DMR4830	1779	40.00	SPR4830	1594	49.00	LPR4830	1711	49.00	PPR4830	1526	58.00	0.90	0.66
48 x 36	DMR4836	1641	28.00	SPR4836	1456	37.00	LPR4836	1540	37.00	PPR4836	1355	46.00	0.90	0.74
48 x 42	DMR4842	1426	15.50	SPR4842	1241	24.50	LPR4842	1274	24.50	PPR4842	1089	33.50	0.90	0.82

PESOS EN LIBRAS ● DIMENSIONES EN PULGADAS ● TODOS LOS PESOS MOSTRADOS SON SIN ACCESORIOS

CONEXIONES COMPACTAS DE JUNTA MECANICA (MJ) HIERRO DUCTIL CLASE 350 DE ACUERDO A ANSI / AWWA C153 / A21.53

TEE MJ x ESLABON GIRATORIO (SWIVEL)

Diámetro	No. de Parte	H	S	T	T1	Peso
6 x 4	DMH64	4.00	10.00	0.36	0.34	x
6 x 6	DMH66	5.00	10.00	0.36	0.36	77.00
8 x 6	DMH86	5.00	11.00	0.38	0.36	89.00
8 x 8	DMH88	6.50	11.00	0.38	0.38	116.00
10 x 4	DMH104	4.00	12.50	0.40	0.34	95.00
10 x 6	DMH106	5.00	12.50	0.40	0.36	113.00
10 x 8	DMH108	6.50	12.50	0.40	0.38	129.00
12 x 4	DMH124	4.00	13.50	0.42	0.34	x
12 x 6	DMH126	5.00	13.50	0.42	0.36	128.00
12 x 8	DMH128	6.50	13.50	0.42	0.38	149.00
12 X 12	DMH1212	8.75	13.50	0.42	0.42	x
14 x 6	DMH146	6.50	15.00	0.47	0.36	211.00
14 x 8	DMH148	7.50	15.00	0.47	0.38	182.00
16 x 6	DMH166	6.50	16.00	0.50	0.36	248.00
16 x 8	DMH168	7.50	16.00	0.50	0.38	298.00
18 x 6	DMH186	6.50	17.00	0.54	0.36	300.00
18 x 8	DMH188	7.50	17.00	0.54	0.38	272.00
20 x 6	DMH206	6.50	18.50	0.57	0.36	358.00
20 x 8	DMH208	8.00	18.50	0.57	0.38	382.00
24 x 6	DMH246	7.00	19.00	0.61	0.36	458.00
24 x 8	DMH248	8.00	19.00	0.61	0.38	477.00
30 x 6	DMH306	7.50	24.50	0.66	0.36	662.00
36 x 6	DMH366	8.00	27.50	0.74	0.36	891.00
36 x 8	DMH368	9.00	27.50	0.74	0.38	936.00

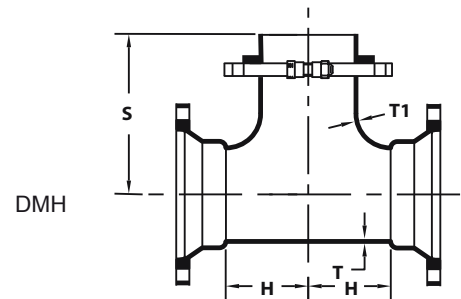

DMH

TEE
MJ x ESLABON
GIRATORIO

CONTRABRIDA ESLABON GIRATORIO (SWIVEL)

Diámetro	No. de Parte	Peso
4	HR4	8
6	HR6	18
8	HR8	15
10	HR10	18
12	HR12	24

HR

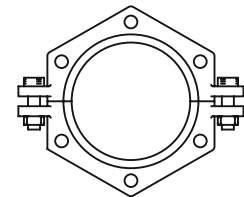

CONTRABRIDA
PARA SWIVEL

ADAPTADOR ESLABON GIRATORIO (SWIVEL)

Diámetro	No. de Parte	L	T	Peso
4	SSA413	13.00	0.34	29
6	SSA613	13.00	0.36	47
6	SSA618	18.00	0.36	58
6	SSA624	24.00	0.36	69
6	SSA630	30.00	0.36	66
6	SSA636	36.00	0.36	75
6	SSA648	48.00	0.36	94
6	SSA660	60.00	0.36	112
6	SSA672	72.00	0.36	131
8	SSA813	13.00	0.38	52
10	SSA1013	13.00	0.40	69
12	SSA1213	13.00	0.42	87

SSA

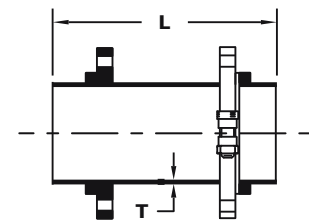

ADAPTADOR MJ x ESPIGA

Diámetro	No. de Parte	Peso	T	T1	A	L
3	DCL3	34.00	0.34	0.36	3.96	20
4	DCL4	50.00	0.35	0.37	4.8	20
6	DCL6	62.00	0.37	0.39	6.9	20
8	DCL8	90.00	0.39	0.41	9.05	20
10	DCL10	105.00	0.41	0.43	11.1	20
12	DCL12	128.00	0.43	0.45	13.2	20

DCL

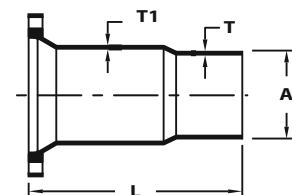

CONEXIONES COMPACTAS DE JUNTA MECANICA (MJ) HIERRO DUCTIL CLASE 350 DE ACUERDO A ANSI / AWWA C153 / A21.53

DESVIACIONES

Diámetro	MJ X MJ		D	L	L1	T	MJ X PE	
	No. de Parte	Peso					No. de Parte	Peso
3 x 6	DMO36	30	6	9	14.50	0.33	DMQ36	29
3 x 12	DMO312	40	12	15	20.50	0.33	DMQ312	39
3 x 18	DMO318	49	18	21	26.50	0.33	DMQ318	48
3 x 24	DMO324	55	24	27	32.50	0.33	DMQ324	53
4 x 6	DMO46	45	6	10	15.50	0.34	DMQ46	44
4 x 12	DMO412	55	12	16	21.50	0.34	DMQ412	54
4 x 18	DMO418	65	18	22	27.50	0.34	DMQ418	63
4 x 24	DMO424	75	24	28	33.50	0.34	DMQ424	72
6 x 6	DMO66	41	6	12	17.50	0.36	DMQ66	54
6 x 12	DMO612	65	12	18	23.50	0.36	DMQ612	64
6 x 18	DMO618	75	18	24	29.50	0.36	DMQ618	72
6 x 24	DMO624	85	24	30	35.50	0.36	DMQ624	82
8 x 6	DMO86	84	6	13	18.50	0.38	DMQ86	78
8 x 12	DMO812	90	12	19	24.50	0.38	DMQ812	88
8 x 18	DMO818	100	18	25	30.50	0.38	DMQ818	96
10 x 6	DMO106	105	6	15	20.50	0.40	DMQ106	102
10 x 12	DMO1012	135	12	21	26.50	0.40	DMQ1012	132
10 x 18	DMO1018	165	18	27	32.50	0.40	DMQ1018	160
12 x 6	DMO126	124	6	17	22.50	0.42	DMQ126	112
12 x 12	DMO1212	153	12	23	28.50	0.42	DMQ1212	146
12 x 18	DMO1218	190	18	29	34.50	0.42	DMQ1218	184
12 x 24	DMO1224	202	24	35	40.50	0.42	DMQ1224	194
12 x 30	DMO1230	213	30	41	46.50	0.42	DMQ1230	205

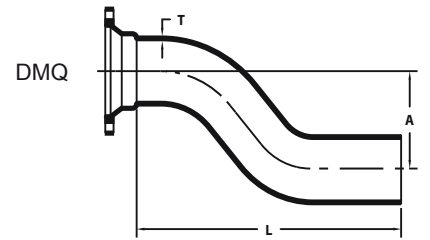
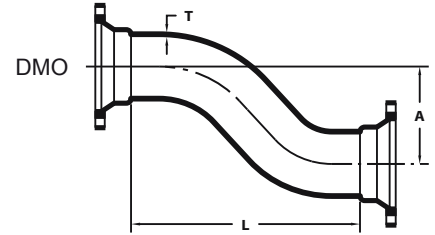

COPELE MJ X MJ

Diámetro	Carrete Corto		L	Carrete Largo		L1	T
	No. de Parte	Peso		No. de Parte	Peso		
3	DMS3	13	7.50	DML3	18	12	0.33
4	DMS4	17	7.50	DML4	20	12	0.34
6	DMS6	28	7.50	DML6	33	12	0.36
8	DMS8	38	7.50	DML8	46	12	0.38
10	DMS10	49	7.50	DML10	62	12	0.40
12	DMS12	56	7.50	DML12	76	12	0.42
14	DMS14	111	9.50	DML14	140	15	0.47
16	DMS16	123	9.50	DML16	170	15	0.50
18	DMS18	160	9.00	DML18	200	15	0.54
20	DMS20	195	9.00	DML20	255	15	0.57
24	DMS24	255	9.00	DML24	335	15	0.61
30	DMS30	500	15.00	DML30	640	24	0.66
36				DML36	925	24	0.74
42				DML42	1150	24	0.82
48				DML48	1435	24	0.90

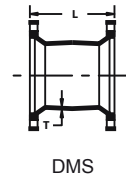
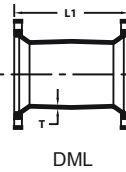

CODO ESLABON GIRATORIO 90° (SWIVEL)

Diámetro	No. de Parte	A	B	T	Peso
3	SSB3	8.50	13.00		x
4	SSB4	9.50	14.00		x
6	SSB6	10.50	16.00	0.36	52
8	SSB8	12.50	18.00	0.38	74
10	SSB10	13.00	20.00	0.40	102
12	SSB12	14.50	22.00		x
14	SSB14	19.50	24.00		x
16	SSB16	20.50	26.00		x
18	SSB18	21.00	28.00		x
20	SSB20	22.50	30.00		x
24	SSB24	25.00	34.00		x
30	SSB30	30.50	40.00		x
36	SSB36	33.50	46.00		x
42	SSB42	38.25	52.00		x
48	SSB48	42.25	58.00		x

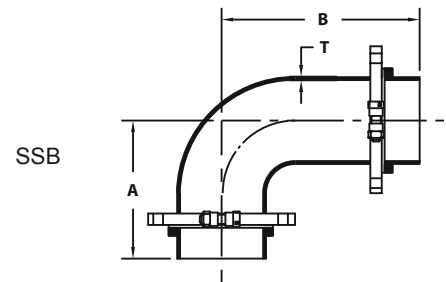

Carrete Doble Uso			
No. de Parte	Peso	L1	T
DDL3	23	12	0.33
DDL4	32	12	0.34
DDL6	50	12	0.36
DDL8	65	12	0.38
DDL10	89	12	0.40
DDL12	104	12	0.68
DDL12	104	12	0.42

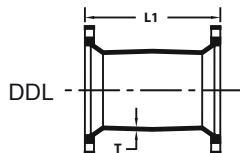

**CONEXIONES COMPACTAS DE JUNTA MECANICA (MJ)
HIERRO DUCTIL CLASE 350 DE ACUERDO A ANSI / AWWA C153 / A21.53**

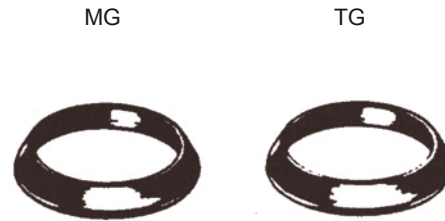
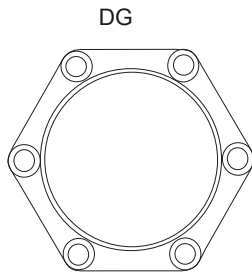

CONTRABRIDA ESTANDAR

Diámetro	No. Parte	Peso
2	DG2	2
3	DG3	4
4	DG4	5
6	DG6	6
8	DG8	7
10	DG10	10
12	DG12	15
14	DG14	23
16	DG16	28
18	DG18	30
20	DG20	43
24	DG24	50
30	DG30	85
36	DG36	115
42	DG42	180
48	DG48	275

EMPAQUES MJ

Diámetro	Estandar		Transición	
	No. de Parte	Peso	No. de Parte	Peso
2	MG2			
3	MG3	0.25	TG3	0.50
4	MG4	0.30	TG4	0.60
6	MG6	0.50	TG6	0.75
8	MG8	0.75	TG8	1.10
10	MG10	0.80	TG10	1.30
12	MG12	1.00	TG12	1.65
14	MG14	1.30		
16	MG16	1.45		
18	MG18	1.60		
20	MG20	1.90		
24	MG24	2.10		
30	MG30	2.30		
36	MG36	2.75		
42	MG42	3.20		
48	MG48	3.65		

CONTRABRIDAS DE RETENCION

Diámetro Nominal del Tubo	No. Parte	Peso	Diámetro Exterior del Tubo Hierro Dúctil AWWA	Presion de Trabajo	Tornillos		
					Cantidad	Dimensiones	Torque (Ft LBS)
3	RMG3	5	3.96	350	4	5/8 X 2	85
4	RMG4	7	4.80	350	4	5/8 X 2	85
6	RMG6	12	6.90	350	6	5/8 X 2	85
8	RMG8	16	9.05	250	9	5/8 X 2	85
10	RMG10	22	11.10	250	16	5/8 X 2	85
12	RMG12	28	13.20	250	16	5/8 X 2	85
14	RMG14	45	15.30	250	20	5/8 X 2	85
16	RMG16	52	17.40	250	24	5/8 X 2	85
18	RMG18	62	19.50	200	24	5/8 X 2	85
20	RMG20	75	21.60	200	28	3/4 X 2-1/2	110
24	RMG24	97	25.80	200	32	3/4 X 2-1/2	110
30	RMG30	196	32.00	100	40	3/4 X 2-1/2	110
36	RMG36	246	38.30	100	48	3/4 X 2-1/2	110
42	RMG42	302	44.50	100	56	3/4 X 2-1/2	110
48	RMG48	380	50.80	100	64	3/4 X 2-1/2	110

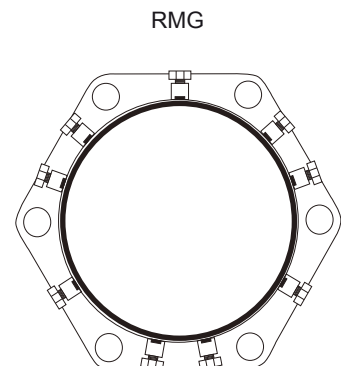

PESOS EN LIBRAS
DIMENSIONES EN PULGADAS
TODOS LOS PESOS MOSTRADOS SON SIN ACCESORIOS

CONEXIONES COMPACTAS DE JUNTA MECANICA (MJ) HIERRO DUCTIL CLASE 350 DE ACUERDO A ANSI / AWWA C153 / A21.53

PAQUETE CONTRABRIDA:
INCLUYE CONTRABRIDA EMPAQUE
MJ Y TORNILLOS "T" ESTANDAR

Diámetro	No. Parte	Peso
2	DGP2	6
3	DGP3	7
4	DGP4	8
6	DGP6	12
8	DGP8	15
10	DGP10	20
12	DGP12	25
14	DGP14	37
16	DGP16	43
18	DGP18	47
20	DGP20	61
24	DGP24	72

PAQUETE CONTRABRIDA DE TRANSICION:
INCLUYE CONTRABRIDA EMPAQUE MJ Y
TORNILLO "T" ESTANDAR

Diámetro	No. Parte	Peso
3	DXP3	7
4	DXP4	8
6	DXP6	12
8	DXP8	15
10	DXP10	20
12	DXP12	25

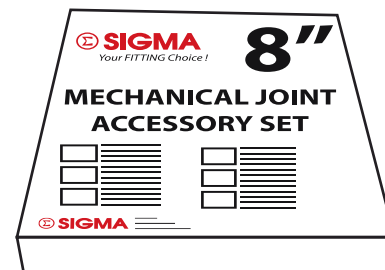

PAQUETE CONTRABRIDA DE RETENCION:
INCLUYE CONTRABRIDA EMPAQUE MJ Y
TORNILLO "T" ESTANDAR

Diámetro	No. Parte	Peso
3	RGP3	9
4	RGP4	10
6	RGP6	15
8	RGP8	19
10	RGP10	25
12	RGP12	32

PAQUETE DE TORNILLOS:
INCLUYE TORNILLO "T" ESTANDAR Y
EMPAQUE MJ

Diámetro	No. Parte	Peso
3	MGP3	3
4	MGP4	4
6	MGP6	6
8	MGP8	7
10	MGP10	8
12	MGP12	9

TORNILLOS CABEZA "T" DE ACERO AL CARBON DE BAJA ALEACION Y ALTA RESISTENCIA

Tornillo Estandar		
Diámetro	No. de Parte	Peso
5/8 x 3	TB30	0.50
3/4 x 3 1/2	TB35	0.75
3/4 x 4	TB40	0.85
3/4 x 4 1/2	TB45	1.00
1 x 5 1/2	TB55	2.25
1 1/4 x 6	TB61	2.50

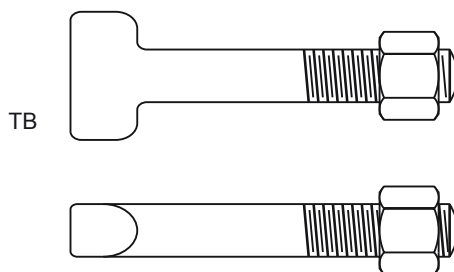

Tornillo Antirotación		
Diámetro	No. de Parte	Peso
3/4 x 3 1/2	ATB35	0.75
3/4 x 4	ATB40	1.00
3/4 x 4 1/2	ATB45	1.25
1 x 5 1/2	ATB55	1.50

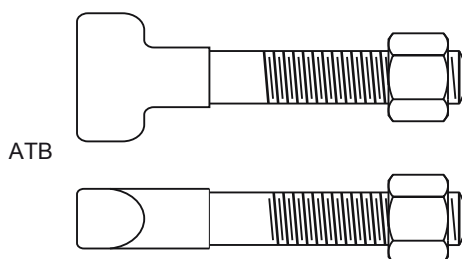

PESOS EN LIBRAS
DIMENSIONES EN PULGADAS
TODOS LOS PESOS MOSTRADOS SON SIN ACCESORIOS

ONE-LOK SERIE D-SLDE TUBERIA HIERRO DUCTIL

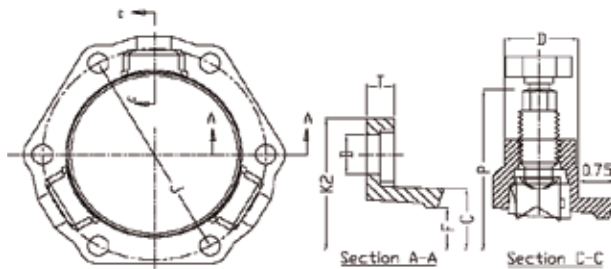

Diámetro Nominal	No. de Parte	Peso Libras	Diámetro Exterior de la Tubería	Dimensiones Generales Pulgadas								Tonillo de Cuñas			Presion de Trabajo PSI
				C	F	D	T	P*	B	J	K2	No.	Tamaño	Torque	
3	D-SLDE3	5.50	3.96	4.84	4.16	1.58	0.55	9.40	0.750	6.19	7.69	2	7/8	80-90	350
4	D-SLDE4	6.50	4.80	5.92	5.00	1.58	0.55	10.24	0.875	7.50	9.12	2	7/8	80-90	350
6	D-SLDE6	10.00	6.90	8.02	7.10	1.58	0.60	12.34	0.875	9.50	11.12	3	7/8	80-90	350
8	D-SLDE8	14.50	9.05	10.17	9.25	1.63	0.75	14.32	0.875	11.75	13.37	4	7/8	80-90	350
10	D-SLDE10	23.00	11.10	12.22	11.30	1.58	0.85	16.54	0.875	14.00	15.62	6	7/8	80-90	350
12	D-SLDE12	29.00	13.20	14.32	13.40	1.58	0.85	18.80	0.875	16.25	17.88	8	7/8	80-90	350
14	D-SLDE14	39.60	15.30	16.40	15.55	1.58	1.13	21.20	0.875	18.75	20.25	10	7/8	80-90	350
16	D-SLDE16	49.67	17.40	18.50	17.54	1.77	1.21	23.74	0.875	21.00	22.50	12	7/8	80-90	350
18	D-SLDE18	60.33	19.50	20.60	19.64	1.77	1.25	25.84	0.875	23.25	24.75	12	7/8	80-90	250
20	D-SLDE20	69.00	21.60	22.70	21.74	1.87	1.25	27.94	0.875	25.50	27.00	14	7/8	80-90	250
24	D-SLDE24	103.67	25.80	26.88	25.95	1.92	1.47	32.14	0.875	30.00	31.50	16	7/8	80-90	250
30*	D-SLDE30	158.67	32.00	33.29	32.17	2.13	1.65	39.30	1.125	36.88	39.12	20	1	115-125	250
36*	D-SLDE36	234.50	38.30	39.59	38.47	3.15	1.75	46.07	1.125	43.75	46.00	24	1	115-125	250
42*	D-SLDE42	344.00	44.50	45.79	44.67	3.56	2.25	53.25	1.380	50.62	53.38	28	1 1/4	115-125	250
48*	D-SLDE48	456.00	50.80	52.09	50.97	3.81	2.25	59.55	1.380	57.50	60.26	32	1 1/4	115-125	250

Materiales

Hierro Dúctil ASTM A536, grado 65-45-12.

ONE-LOK SERIE D-SLCE TUBERIA PVC AWWA C900-905

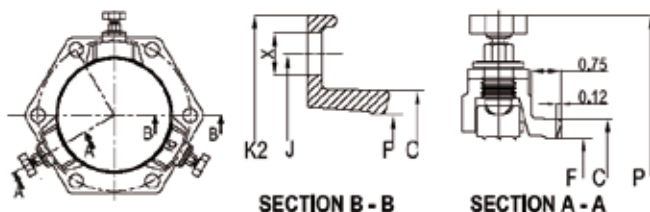

Diámetro Nominal	No. de Parte	Peso Libras	Diámetro Exterior de la Tubería	Dimensiones Generales Pulgadas								Tonillos de Cuñas			Presion de Trabajo PSI
				C	F	D	T	P*	B	J	K2	No.	Tamaño	Torque	
3	D-SLCE3	6.21		3.50	4.76	3.60	7.18	0.60	9.420	8.50	0.75	6.14	2	7/8	45-55
4	D-SLCE4	6.78	4.80	4.50	5.92	4.90	7.92	0.60	10.220	9.30	0.88	7.5	2	7/8	50-60
6	D-SLCE6	10.28	6.90	6.63	8.01	7.00	10.00	0.60	12.870	11.95	0.88	9.5	3	7/8	50-60
8	D-SLCE8	14.48	9.05	8.63	10.17	9.15	12.18	0.75	14.370	13.45	0.88	11.75	4	7/8	50-60
10	D-SLCE10	21.40	11.10	10.75	12.22	11.20	14.60	0.85	16.680	15.76	0.88	14	6	7/8	50-60
12	D-SLCE12	26.96	13.20	12.75	14.32	13.30	16.64	0.85	18.580	17.66	0.88	16.25	8	7/8	50-60
14	D-SLCE14	33.67	15.30		16.40	15.44	20.25	1.20	21.680	19.98	0.88	18.75	10	7/8	55-65
16	D-SLCE16	41.67	17.40		18.50	17.54	22.45	1.21	23.650	21.95	0.88	21	12	7/8	55-65
18	D-SLCE18	49.50	19.50		20.60	19.64	24.75	1.25	25.790	24.09	0.88	23.25	12	7/8	55-65
20	D-SLCE20	61.17	21.60		22.70	21.74	27.00	1.34	28.160	26.46	0.88	25.5	14	7/8	55-65
24	D-SLCE24	79.33	25.80		26.90	25.94	31.50	1.46	32.700	31.00	0.88	30	16	7/8	55-65
30*	D-SLCE30	198.00	32.00		33.29	32.17	38.42	2.00	41.920	39.92	1.13	36.88	20	1	65-75
36*	D-SLCE36	248.00	38.30		39.59	38.47	46.00	2.00	48.780	46.78	1.13	43.75	24	1	65-75

Materiales

Hierro Dúctil ASTM A536, grado 65-45-12.

PV-LOK SERIE PWP PARA UNION ESPIGA CAMPANA EN TUBERIA AWWA C900-C905

Diámetro Nominal	No. de Parte	Diámetro exterior Tubería PVC AWWA C900 Y C905	A	B	C (max)	Varillas de sujeción		Tuerca Varillas de sujeción		Tornillos T			Peso Libras
						No. Piezas	Diámetro y Largo	No. Piezas	Medida	No. Piezas	Diámetro y Largo	Torque Mínimo	
4	PWP-C4	4.80	1.2	9	13	2	3/4x15	4	3/4	4	5/8 x 3 3/8	85	14.36
6	PWP-C6	6.90	1.2	11.52	13	2	3/4x15	4	3/4	4	5/8 x 3 3/8	85	16.44
8	PWP-C8	9.05	1.75	12.81	13	2	3/4x15	4	3/4	4	3/4 x 3 7/8	100	27
10	PWP-C10	11.10	1.75	16.88	16	4	3/4x18	8	3/4	4	7/8 x 4 3/8	125	44.4
12	PWP-C12	13.20	1.75	19.12	22	4	3/4x24	8	3/4	4	7/8 x 4 3/8	125	50.64
14	PWP-C14	15.30	3.5	21.1	22	6	3/4x30	12	3/4	4	7/8 x 6 1/4	130	101.61
16	PWP-C16	17.40	3.5	23.58	22	6	3/4x30	12	3/4	4	7/8 x 6 1/4	130	114.15
18	PWP-C18	19.50	4.25	25.8	22	8	3/4x30	16	3/4	4	1 x 6 1/4	130	164.97
20	PWP-C20	21.60	5	29.06	22	8	3/4x36	16	3/4	8	1 1/4 x 6-1/2	130	234.5
24	PWP-C24	25.80	5	34.64	22	10	3/4x36	20	3/4	8	1 1/4 x 6-1/2	130	288.5
30	PWP-C30	32.00	5.5	41.8	38	10	1x40	20	1	8	1 1/4 x 8-1/2	130	463.75
36	PWP-C36	38.30	5.5	49.04	38	12	1x40	24	1	8	1 1/4 x 8-1/2	130	520.4
42	PWP-C42	44.50	6.26	57.18	46	16	1 1/4x48	32	1 1/4	8	1 1/2 x 9	175	983.76
48	PWP-C48	50.80	6.26	63.48	46	16	1 1/4x48	32	1 1/4	8	1 1/2 x 9	175	1058.5

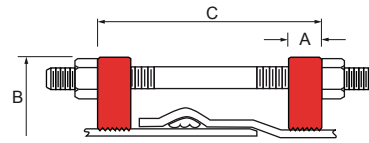

PV-LOK SERIE PWM PARA UNIR TUBERIA AWWA C900 Y C905 CON CONEXIONES JUNTA MECANICA DE HIERRO DUCTIL

Diámetro Nominal	No. de Parte	Diámetro exterior Tubería PVC AWWA C900 Y C905.	A	B	C (max)	Varillas de sujeción		Tuerca Varillas de sujeción		Tornillos T			Peso Libras
						No. Piezas	Diámetro y Largo	No. Piezas	Medida	No. Piezas	Diámetro y Largo	Torque Mínimo	
4	PWM-C4	4.80	1.20	9.00	6	2	3/4 x 7	4	3/4	2	5/8 x 3 3/8	85	7.48
6	PWM-C6	6.90	1.20	11.52	6	2	3/4 x 7	4	3/4	2	5/8 x 3 3/8	85	8.62
8	PWM-C8	9.05	1.75	12.81	6	2	3/4 x 7	4	3/4	2	3/4 x 3 7/8	100	13.9
10	PWM-C10	11.10	1.75	16.88	8	4	3/4 x 9	8	3/4	2	7/8 x 4 3/8	125	21.83
12	PWM-C12	13.20	1.75	19.12	8	4	3/4 x 9	8	3/4	2	7/8 x 4 3/8	125	24.95
14	PWM-C14	15.30	3.50	21.10	15	6	3/4 x 17	18	3/4	2	7/8 x 6 1/4	130	52.43
16	PWM-C16	17.40	3.50	23.58	15	6	3/4 x 17	18	3/4	2	7/8 x 6 1/4	130	58.7
18	PWM-C18	19.50	4.25	25.80	15	8	3/4 x 17	24	3/4	2	1 x 6 1/4	130	86.25
20	PWM-C20	21.60	5.00	29.06	22	8	3/4 x 24	24	3/4	4	1 1/4 x 6-1/2	130	123.17
24	PWM-C24	25.80	5.00	34.64	22	10	3/4 x 24	30	3/4	4	1 1/4 x 6-1/2	130	151
30	PWM-C30	32.00	5.50	41.80	22	10	1 x 24	30	1	4	1 1/4 x 8-1/2	130	240.95
36	PWM-C36	38.30	5.50	49.04	22	12	1 x 24	36	1	4	1 1/4 x 8-1/2	130	269.8
42	PWM-C42	44.50	6.26	57.18	32	16	1 1/4 x 36	48	1 1/4	4	1 1/2 x 9	175	563.88
48	PWM-C48	50.80	6.26	63.48	32	16	1 1/4 x 36	48	1 1/4	4	1 1/2 x 9	175	601.75

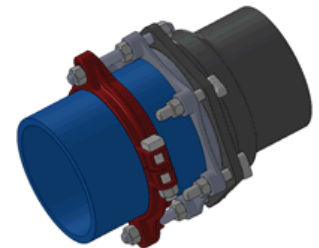
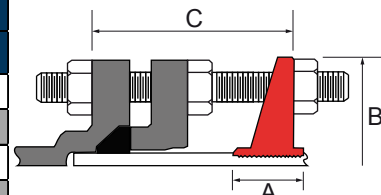

PV-LOK SERIE PWH PARA UNION DE ESPIGA CAMPANA EN TUBERIA AWWA C900-C905

Diámetro Nominal	No. de Parte	Presión de Trabajo	No. Varillas de Sujeción Piezas	Largo Varilla de Sujeción	Diámetro Varilla de Sujeción	Mínima distancia de Instalación	Peso Libras
					Pulgas		
4	PWH-C4	200	2	17	3/4	6.75	15
6	PWH-C6	200	2	17	3/4	8.75	23
8	PWH-C8	200	2	17	3/4	11	32
10	PWH-C10	200	4	24	3/4	13.25	49
12	PWH-C12	200	4	24	3/4	15.5	55

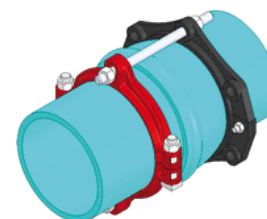

Materiales PWP, PWM Y PWH

Anillos de Sujeción: Hierro Dúctil ASTM A536, Grado 65-45-12

Tornillo de fijación: Hexagonal en acero de alta resistencia, bajo la norma ASTM A449, galvanizado al B633, Tipo III Sc.1 para la resistencia a la corrosión

Tornillo T, Varillas de sujeción: tornillo y tuerca son de acero de baja aleación alta resistencia, de según la norma AWWA / ANSI C111/A21.11

SHI de Mexico S. de R.L. de C.V.

www.simexco.com.mx