



# SIMEX

HACIENDO LA EXCELENCIA UN HABITO



# SIGMA FLOW

## *Lista de Precios Junio 2022*



SHI de México S. de R.L. de C.V.

## INDICE

|   |           |
|---|-----------|
| <b>VALVULAS.....</b>  | <b>1</b>  |
| <b>CODOS Y TAPAS CIEGAS.....</b>  | <b>1</b>  |
| <b>TEES, CRUCES Y REDUCCIONES.....</b>  | <b>2</b>  |
| <b>EXTREMIDADES CARRETES Y TORNILLOS .....</b>  | <b>3</b>  |
| <b>JUNTAS GIBAULT, ABRAZADERAS FO.FO., EMPAQUES, BRIDAS Y<br/>ABRAZADERAS CUERPO HIERRO DUCTIL CON BANDA ACERO INOXIDABLE .....</b> | <b>4</b>  |
| <b>ADAPTADOR BRIDADO UNIVERSAL, COPLE UNIVERSAL DE RANGO AMPLIO Y<br/>ADAPTADOR PARA PEAD .....</b>                                 | <b>5</b>  |
| <b>VALVULAS DE MARIPOSA .....</b>   | <b>6</b>  |
| <b>VALVULAS ELIMINADORAS DE AIRE, DE ADMISION Y EXPULSION DE AIRE Y<br/>VALVULAS AUTOMATICAS .....</b>                              | <b>7</b>  |
| <b>ABRAZADERAS DE REPARACION DE ACERO INOXIDABLE, COPLE DE<br/>DESMONTAJE, FILTRO TIPO Y .....</b>                                  | <b>8</b>  |
| <b>ALCANTARILLADO.....</b>  | <b>9</b>  |
| <b>CONTRAMARCOS, ALCANTARILLADO POLIETILENO JUNTAS TIPO DRESER .....</b>  | <b>10</b> |

### VALVULAS

| DIAMETRO |     | VASTAGO FIJO |                  |                  |                    |                  | VASTAGO SALIENTE RESILENTE | CHECK RESILENTE | CHECK BRONCE |
|----------|-----|--------------|------------------|------------------|--------------------|------------------|----------------------------|-----------------|--------------|
| pulg.    | mm. | BRONCE       | BRONCE C/VOLANTE | FLEXIBLE BRIDADA | FLEX C/VOL BRIDADA | FLEXIBLE ESPIGAS |                            |                 |              |
| 2        | 51  | \$ 5,598     | \$ 5,874         | \$ 3,294         | \$ 3,525           | \$ 2,688         | \$ 5,017                   | \$ 3,350        |              |
| 2 1/2    | 64  | \$ 5,890     | \$ 6,210         | \$ 3,934         | \$ 4,159           | \$ 3,151         | \$ 6,261                   | \$ 4,146        |              |
| 3        | 76  | \$ 8,164     | \$ 8,484         | \$ 4,935         | \$ 5,203           | \$ 3,950         | \$ 8,181                   | \$ 5,312        |              |
| 4        | 102 | \$ 10,754    | \$ 11,180        | \$ 6,616         | \$ 7,020           | \$ 5,115         | \$ 10,772                  | \$ 7,329        |              |
| 6        | 152 | \$ 16,323    | \$ 16,919        | \$ 10,588        | \$ 11,173          | \$ 8,990         | \$ 18,185                  | \$ 14,616       |              |
| 8        | 203 | \$ 28,386    | \$ 29,058        | \$ 17,631        | \$ 18,370          | \$ 15,440        | \$ 28,230                  | \$ 27,165       |              |
| 10       | 254 | \$ 41,506    | \$ 43,389        | \$ 28,790        | \$ 29,580          |                  | \$ 39,586                  | \$ 37,149       |              |
| 12       | 305 | \$ 59,554    | \$ 62,091        | \$ 40,033        | \$ 41,083          |                  | \$ 57,076                  | \$ 53,098       |              |
| 14       | 356 | \$ 104,832   | \$ 106,674       | \$ 79,963        | \$ 80,836          |                  |                            | \$ 78,054       |              |
| 16       | 406 | \$ 129,794   | \$ 131,636       | \$ 96,175        | \$ 96,857          |                  |                            | \$ 140,229      |              |
| 18       | 457 | \$ 197,381   | \$ 199,918       | \$ 156,747       | \$ 157,415         |                  |                            |                 | \$ 201,577   |
| 20       | 508 | \$ 240,381   | \$ 240,381       | \$ 217,981       |                    |                  |                            |                 | \$ 262,228   |
| 24       | 610 | \$ 350,037   | \$ 350,037       | \$ 298,634       |                    |                  |                            |                 | \$ 407,380   |
| 30       | 762 |              |                  | \$ 753,587       |                    |                  |                            |                 | \$ 695,527   |
| 36       | 914 |              |                  | \$ 1,060,427     |                    |                  |                            |                 | \$ 1,221,096 |

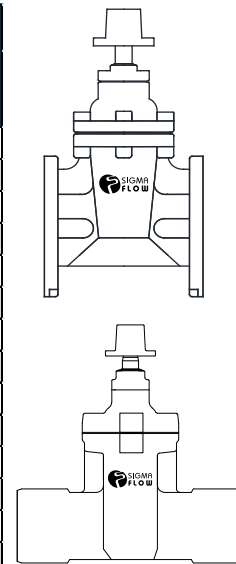

### CONEXIONES BRIDADAS



CODO 90



CODO 45



CODO 22 1/2



CODO 11 1/4



TAPAS CIEGAS 2 A 10"



TAPAS CIEGAS 12 A 36"

### CODOS

| DIMENSION | GRADOS    |           |           |           |
|-----------|-----------|-----------|-----------|-----------|
|           | 90°       | 45°       | 22 1/2°   | 11 1/2°   |
| 2         | \$ 1,163  | \$ 836    | \$ 836    | \$ 836    |
| 2 1/2     | \$ 1,393  | \$ 1,115  | \$ 998    | \$ 998    |
| 3         | \$ 1,816  | \$ 1,452  | \$ 1,393  | \$ 1,393  |
| 4         | \$ 3,268  | \$ 2,905  | \$ 2,905  | \$ 2,905  |
| 6         | \$ 4,721  | \$ 3,996  | \$ 3,996  | \$ 3,996  |
| 8         | \$ 7,628  | \$ 6,537  | \$ 6,537  | \$ 6,537  |
| 10        | \$ 11,985 | \$ 9,805  | \$ 9,805  | \$ 9,406  |
| 12        | \$ 17,069 | \$ 14,164 | \$ 14,892 | \$ 14,284 |
| 14        | \$ 24,053 | \$ 18,247 | \$ 18,213 | \$ 18,213 |
| 16        | \$ 30,689 | \$ 23,225 | \$ 23,068 | \$ 23,068 |
| 18        | \$ 37,325 | \$ 27,606 | \$ 27,116 | \$ 27,116 |
| 20        | \$ 49,265 | \$ 36,524 | \$ 35,210 | \$ 35,210 |
| 24        | \$ 76,447 | \$ 53,512 | \$ 51,804 | \$ 52,194 |
| 30        | Cotizar   | Cotizar   | Cotizar   | Cotizar   |
| 36        | Cotizar   | Cotizar   | Cotizar   | Cotizar   |
| 42        | Cotizar   | Cotizar   | Cotizar   | Cotizar   |

### TAPAS CIEGAS

| DIMENSION | PRECIO    |
|-----------|-----------|
| 2         | \$ 320    |
| 2 1/2     | \$ 461    |
| 3         | \$ 653    |
| 4         | \$ 1,017  |
| 6         | \$ 1,744  |
| 8         | \$ 2,761  |
| 10        | \$ 4,285  |
| 12        | \$ 5,520  |
| 14        | \$ 9,123  |
| 16        | \$ 12,027 |
| 18        | \$ 15,344 |
| 20        | \$ 17,999 |
| 24        | \$ 30,689 |
| 30        | \$ 40,473 |
| 36        | \$ 64,332 |
| 42        | Cotizar   |

### TEE, CRUCES Y REDUCCIONES

| DIMENSION | TEE      | CRUZ     | RED. |
|-----------|----------|----------|------|
| 2 x 2     | \$ 1,601 | \$ 1,843 |      |

|           |          |          |          |
|-----------|----------|----------|----------|
| 2 ½ x 2   | \$ 1,843 | \$ 1,997 | \$ 1,075 |
| 2 ½ x 2 ½ | \$ 1,997 | \$ 2,304 |          |

|         |          |          |          |
|---------|----------|----------|----------|
| 3 x 2   | \$ 2,562 | \$ 3,072 | \$ 1,121 |
| 3 x 2 ½ | \$ 2,611 | \$ 3,226 | \$ 1,601 |
| 3 x 3   | \$ 2,883 | \$ 4,148 |          |

|         |          |          |          |
|---------|----------|----------|----------|
| 4 x 2   | \$ 3,683 | \$ 4,148 | \$ 1,762 |
| 4 x 2 ½ | \$ 3,840 | \$ 4,455 | \$ 1,997 |
| 4 x 3   | \$ 4,324 | \$ 4,916 | \$ 2,242 |
| 4 x 4   | \$ 4,644 | \$ 5,765 |          |

|         |          |          |          |
|---------|----------|----------|----------|
| 6 x 2   | \$ 5,530 | \$ 5,991 | \$ 2,562 |
| 6 x 2 ½ | \$ 5,684 | \$ 6,298 | \$ 2,611 |
| 6 x 3   | \$ 6,245 | \$ 6,605 | \$ 2,883 |
| 6 x 4   | \$ 6,566 | \$ 8,007 | \$ 3,203 |
| 6 x 6   | \$ 6,886 | \$ 8,648 |          |

|         |           |           |          |
|---------|-----------|-----------|----------|
| 8 x 2   | \$ 7,681  | \$ 8,449  | \$ 3,687 |
| 8 x 2 ½ | \$ 7,681  | \$ 7,991  | \$ 3,687 |
| 8 x 3   | \$ 9,608  | \$ 9,985  | \$ 4,148 |
| 8 x 4   | \$ 10,249 | \$ 10,753 | \$ 4,644 |
| 8 x 6   | \$ 10,569 | \$ 12,011 | \$ 5,445 |
| 8 x 8   | \$ 11,210 | \$ 14,092 |          |

|          |           |           |          |
|----------|-----------|-----------|----------|
| 10 x 2   | \$ 12,289 | \$ 13,825 |          |
| 10 x 2 ½ | \$ 12,289 | \$ 10,724 | \$ -     |
| 10 x 3   | \$ 13,518 | \$ 14,286 | \$ 5,684 |
| 10 x 4   | \$ 14,893 | \$ 15,361 | \$ 6,245 |
| 10 x 6   | \$ 15,694 | \$ 17,455 | \$ 6,566 |
| 10 x 8   | \$ 16,334 | \$ 19,217 | \$ 8,007 |
| 10 x 10  | \$ 19,537 | \$ 24,021 |          |

|         |           |           |           |
|---------|-----------|-----------|-----------|
| 12 x 3  | \$ 21,352 | \$ 20,782 | \$ 8,141  |
| 12 x 4  | \$ 21,139 | \$ 21,659 | \$ 8,648  |
| 12 x 6  | \$ 21,459 | \$ 23,220 | \$ 9,448  |
| 12 x 8  | \$ 22,580 | \$ 24,982 | \$ 10,569 |
| 12 x 10 | \$ 26,103 | \$ 30,106 | \$ 12,331 |
| 12 x 12 | \$ 28,025 | \$ 33,469 |           |

|         |           |           |           |
|---------|-----------|-----------|-----------|
| 14 x 4  | \$ 29,444 | \$ 29,730 | \$ 12,313 |
| 14 x 6  | \$ 30,337 | \$ 32,300 | \$ 12,492 |
| 14 x 8  | \$ 31,986 | \$ 34,441 | \$ 14,098 |
| 14 x 10 | \$ 32,300 | \$ 37,296 | \$ 15,347 |
| 14 x 12 | \$ 34,441 | \$ 40,865 | \$ 18,726 |
| 14 x 14 | \$ 36,023 | \$ 42,828 |           |

|         |           |           |           |
|---------|-----------|-----------|-----------|
| 16 x 4  | \$ 37,118 | \$ 34,644 | \$ -      |
| 16 x 6  | \$ 38,583 | \$ 39,616 | \$ 15,221 |
| 16 x 8  | \$ 39,314 | \$ 42,115 | \$ 16,953 |
| 16 x 10 | \$ 41,143 | \$ 40,261 | \$ 20,037 |
| 16 x 12 | \$ 43,154 | \$ 48,896 | \$ 22,472 |
| 16 x 14 | \$ 42,828 | \$ 50,845 | \$ 23,782 |
| 16 x 16 | \$ 45,532 | \$ 54,862 |           |

| DIMENSION | TEE       | CRUZ      | RED.      |
|-----------|-----------|-----------|-----------|
| 18 x 4    | \$ 37,653 |           |           |
| 18 x 6    | \$ 38,902 | \$ 39,586 | \$ 19,273 |
| 18 x 8    | \$ 40,152 | \$ 43,364 | \$ 19,451 |
| 18 x 10   | \$ 41,222 | \$ 41,635 | \$ 21,414 |
| 18 x 12   | \$ 44,434 | \$ 46,135 | \$ 25,093 |
| 18 x 14   | \$ 49,368 | \$ 52,290 | \$ 26,404 |
| 18 x 16   | \$ 52,643 | \$ 64,006 | \$ 27,481 |
| 18 x 18   | \$ 55,223 | \$ 50,529 |           |

|         |           |           |           |
|---------|-----------|-----------|-----------|
| 20 x 4  | \$ 48,182 |           |           |
| 20 x 6  | \$ 49,431 | \$ 51,138 | \$ 23,912 |
| 20 x 8  | \$ 50,145 | \$ 51,138 | \$ 24,448 |
| 20 x 10 | \$ 51,394 | \$ 54,428 | \$ 25,162 |
| 20 x 12 | \$ 53,357 | \$ 57,718 | \$ 27,838 |
| 20 x 14 | \$ 53,892 | \$ 60,317 | \$ 28,731 |
| 20 x 16 | \$ 67,109 | \$ 66,408 | \$ 33,146 |
| 20 x 18 | \$ 66,384 | \$ 79,882 | \$ 33,192 |
| 20 x 20 | \$ 81,084 | \$ 85,342 |           |

|         |            |            |           |
|---------|------------|------------|-----------|
| 24 x 6  | \$ 68,347  |            | \$ -      |
| 24 x 8  | \$ 69,596  | \$ 80,810  | \$ 37,296 |
| 24 x 10 | \$ 71,202  | \$ 70,526  | \$ 44,023 |
| 24 x 12 | \$ 73,874  | \$ 73,819  | \$ 38,902 |
| 24 x 14 | \$ 90,210  | \$ 89,060  | \$ 39,616 |
| 24 x 16 | \$ 74,057  | \$ 92,362  | \$ 48,182 |
| 24 x 18 | \$ 112,227 | \$ 116,126 | \$ 50,137 |
| 24 x 20 | \$ 101,539 | \$ 144,316 | \$ 58,866 |
| 24 x 24 | \$ 110,263 | \$ 127,057 |           |

|         |         |         |         |
|---------|---------|---------|---------|
| 30 x 6  | Cotizar | Cotizar |         |
| 30 x 8  | Cotizar | Cotizar |         |
| 30 x 10 | Cotizar | Cotizar |         |
| 30 x 12 | Cotizar | Cotizar |         |
| 30 x 14 | Cotizar | Cotizar |         |
| 30 x 16 | Cotizar | Cotizar | Cotizar |
| 30 x 18 | Cotizar | Cotizar | Cotizar |
| 30 x 20 | Cotizar | Cotizar | Cotizar |
| 30 x 24 | Cotizar | Cotizar | Cotizar |
| 30 x 30 | Cotizar | Cotizar |         |

|         |         |         |         |
|---------|---------|---------|---------|
| 36 x 12 | Cotizar | Cotizar |         |
| 36 x 14 | Cotizar | Cotizar |         |
| 36 x 16 | Cotizar | Cotizar |         |
| 36 x 18 | Cotizar | Cotizar | Cotizar |
| 36 x 20 | Cotizar | Cotizar | Cotizar |
| 36 x 24 | Cotizar | Cotizar | Cotizar |
| 36 x 30 | Cotizar | Cotizar | Cotizar |
| 36 x 36 | Cotizar | Cotizar |         |

|         |         |         |         |
|---------|---------|---------|---------|
| 42 x 12 | Cotizar |         |         |
| 42 x 14 | Cotizar | Cotizar | Cotizar |
| 42 x 16 | Cotizar | Cotizar | Cotizar |
| 42 x 18 | Cotizar | Cotizar | Cotizar |
| 42 x 20 | Cotizar | Cotizar | Cotizar |
| 42 x 24 | Cotizar | Cotizar | Cotizar |
| 42 x 30 | Cotizar | Cotizar | Cotizar |
| 42 x 36 | Cotizar | Cotizar | Cotizar |
| 42 x 42 | Cotizar | Cotizar | Cotizar |

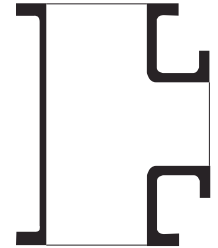

TEE

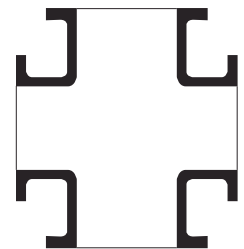

CRUZ

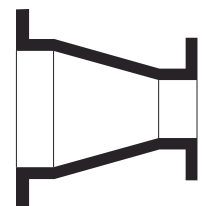

REDUCCION

### EXTREMIDADES Y CARRETES

#### EXTREMIDAD

| DIMENSION | ASBESTO CEMENTO |           |           | PVC       |
|-----------|-----------------|-----------|-----------|-----------|
|           | A5 - A7         | A - 10    | A - 14    |           |
| 2         | \$ 793          | \$ 906    | \$ 906    | \$ 620    |
| 2 ½       | \$ 1,023        | \$ 1,232  | \$ 1,232  | \$ 828    |
| 3         | \$ 1,140        | \$ 1,140  | \$ 1,140  | \$ 1,140  |
| 4         | \$ 1,430        | \$ 1,430  | \$ 1,430  | \$ 1,430  |
| 6         | \$ 2,188        | \$ 2,188  | \$ 2,188  | \$ 2,188  |
| 8         | \$ 3,813        | \$ 3,813  | \$ 3,813  | \$ 3,629  |
| 10        | \$ 5,941        | \$ 5,941  | \$ 5,941  | \$ 5,668  |
| 12        | \$ 8,015        | \$ 8,015  | \$ 8,015  | \$ 7,647  |
| 14        | \$ 12,543       | \$ 12,543 | \$ 12,543 | \$ 11,952 |
| 16        | \$ 19,825       | \$ 19,825 | \$ 19,825 | \$ 17,726 |
| 18        | Cotizar         | Cotizar   | Cotizar   | \$ 22,141 |
| 20        | Cotizar         | Cotizar   | Cotizar   | Cotizar   |
| 24        | Cotizar         | Cotizar   | Cotizar   | \$ 36,344 |
| 30        | Cotizar         | Cotizar   | Cotizar   | Cotizar   |
| 36        | Cotizar         | Cotizar   | Cotizar   | Cotizar   |

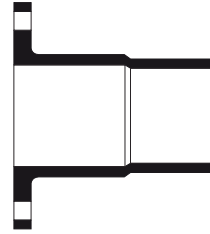

#### CARRETE

| DIMENSION | LONGITUD |           |
|-----------|----------|-----------|
|           | 25 CMS.  | 50 CMS.   |
| 2         | \$ 1,077 | \$ 1,462  |
| 2 ½       | \$ 1,305 | \$ 1,948  |
| 3         | \$ 1,798 | \$ 2,782  |
| 4         | \$ 2,047 | \$ 3,334  |
| 6         | \$ 3,032 | \$ 4,618  |
| 8         | \$ 5,762 | \$ 8,764  |
| 10        | \$ 6,891 | \$ 10,249 |
| 12        | \$ 9,681 | \$ 14,194 |



### TORNILLOS

| MEDIDA     | PRECIO UNITARIO |
|------------|-----------------|
| 7/16 x 4   | \$ 21           |
| 7/16 x 4 ½ | \$ 23           |

| MEDIDA  | PRECIO UNITARIO |
|---------|-----------------|
| 7/8 x 4 | \$ 91           |
| 7/8 x 6 | \$ 121          |

|           |       |
|-----------|-------|
| 1/2 x 2 ½ | \$ 19 |
| 1/2 x 3   | \$ 19 |
| 1/2 x 3 ½ | \$ 21 |
| 1/2 x 4   | \$ 23 |
| 1/2 x 4 ½ | \$ 28 |
| 1/2 x 5   | \$ 31 |
| 1/2 x 6   | \$ 38 |

|       |        |
|-------|--------|
| 1 x 4 | \$ 123 |
| 1 x 5 | \$ 141 |
| 1 x 8 | \$ 229 |

|           |        |
|-----------|--------|
| 1 1/8 x 5 | \$ 327 |
|-----------|--------|

|         |        |
|---------|--------|
| 1 ½ x 7 | \$ 575 |
|---------|--------|

|           |       |
|-----------|-------|
| 5/8 x 2 ½ | \$ 31 |
| 5/8 x 3   | \$ 34 |
| 5/8 x 3 ½ | \$ 39 |
| 5/8 x 5   | \$ 53 |
| 5/8 x 5 ½ | \$ 55 |

|           |       |
|-----------|-------|
| 3/4 x 3 ½ | \$ 50 |
| 3/4 x 4   | \$ 61 |
| 3/4 x 6   | \$ 80 |

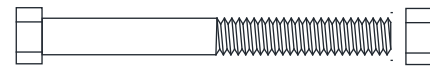

### JUNTAS GIBAULT, ABRAZADERAS, EMPAQUES, BRIDAS

#### JUNTAS GIBAULT

| DIMENSION | A5 - A7  | A - 10   | A - 14   | PVC      |
|-----------|----------|----------|----------|----------|
| 2         | \$ 208   | \$ 223   | \$ 223   | \$ 181   |
| 2 ½       | \$ 223   | \$ 249   | \$ 249   | \$ 223   |
| 3         | \$ 249   | \$ 249   | \$ 308   | \$ 249   |
| 4         | \$ 373   | \$ 373   | \$ 373   | \$ 357   |
| 6         | \$ 632   | \$ 681   | \$ 681   | \$ 632   |
| 8         | \$ 958   | \$ 977   | \$ 977   | \$ 825   |
| 10        | \$ 1,227 | \$ 1,313 | \$ 1,555 | \$ 912   |
| 12        | \$ 1,570 | \$ 1,772 | \$ 1,836 | \$ 1,555 |
| 14        | \$ 2,455 | \$ 2,547 | \$ 2,669 | \$ 1,836 |
| 16        | \$ 2,687 | \$ 2,819 | \$ 3,388 | \$ 2,547 |
| 18        | \$ 3,259 | \$ 4,226 | \$ 4,248 | \$ 2,759 |
| 20        | \$ 4,422 | \$ 4,525 | \$ 6,133 | \$ 3,667 |
| 24        | Cotizar  | Cotizar  | Cotizar  | Cotizar  |
| 30        | Cotizar  | Cotizar  | Cotizar  | Cotizar  |
| 36        | Cotizar  | Cotizar  | Cotizar  | ND       |

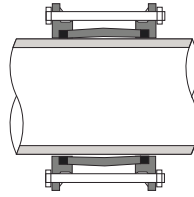

#### ABRAZADERAS

| DIMENSION | FoFo AC<br>1/2 y 3/4"<br>NPT | FoFo PVC<br>1/2 y 3/4"<br>NPT |
|-----------|------------------------------|-------------------------------|
| 2         | \$ 122                       | \$ 122                        |
| 2 ½       | \$ 140                       | \$ 130                        |
| 3         | \$ 195                       | \$ 140                        |
| 4         | \$ 219                       | \$ 218                        |
| 6         | \$ 310                       | \$ 220                        |
| 8         | \$ 407                       | \$ 407                        |
| 10        | \$ 555                       | \$ 520                        |
| 12        | \$ 783                       | \$ 629                        |

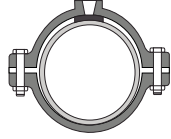

#### EMPAQUES

| DIMENSION | PLOMO    | NEOPRENO | GOMAS GIBAULT |           |
|-----------|----------|----------|---------------|-----------|
|           |          |          | NORMAL        | REFORZADA |
| 2         | \$ 52    | \$ 18    | \$ 11         | \$ 25     |
| 2 ½       | \$ 62    | \$ 23    | \$ 12         | \$ 34     |
| 3         | \$ 75    | \$ 32    | \$ 14         | \$ 39     |
| 4         | \$ 103   | \$ 40    | \$ 20         | \$ 45     |
| 6         | \$ 126   | \$ 46    | \$ 33         | \$ 71     |
| 8         | \$ 243   | \$ 79    | \$ 40         | \$ 95     |
| 10        | \$ 364   | \$ 139   | \$ 63         | \$ 150    |
| 12        | \$ 475   | \$ 165   | \$ 76         | \$ 208    |
| 14        | \$ 663   | \$ 247   | \$ 115        | \$ 367    |
| 16        | \$ 854   | \$ 339   | \$ 124        | \$ 408    |
| 18        | \$ 1,011 | \$ 398   | \$ 162        | \$ 461    |
| 20        | \$ 1,259 | \$ 476   | \$ 190        | \$ 489    |
| 24        | \$ 1,680 | \$ 633   | \$ 256        | \$ 839    |
| 30        | \$ 2,518 | \$ 1,083 | \$ 586        | \$ 1,342  |
| 36        | \$ 3,143 | \$ 1,477 | \$ 778        | \$ 1,588  |

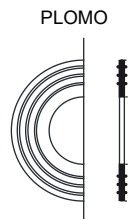

NEOPRENO

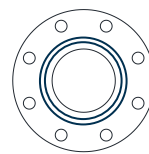

#### BRIDAS

| DIMENSION | TIPO     |          |
|-----------|----------|----------|
|           | C/ROSCA  | SOLDABLE |
| 2         | \$ 330   | \$ 300   |
| 2 ½       | \$ 417   | \$ 360   |
| 3         | \$ 442   | \$ 405   |
| 4         | \$ 656   | \$ 601   |
| 6         | \$ 854   | \$ 772   |
| 8         | \$ 1,454 | \$ 1,293 |
| 10        | \$ -     | \$ 1,789 |
| 12        | \$ -     | \$ 2,929 |
| 14        | \$ -     | \$ 3,869 |
| 16        | \$ -     | \$ 5,009 |
| 18        | \$ -     | \$ 5,578 |
| 20        | \$ -     | \$ 7,061 |
| 24        | \$ -     | \$ 9,912 |
| 30        |          | Cotizar  |
| 36        |          | Cotizar  |

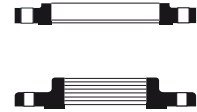

#### ABRAZADERA CUERPO HIERRO DUCTIL CON BANDA ACERO INOXIDABLE

| DIMENSION | RANGO TUBERIA | ROSCA    |                    |
|-----------|---------------|----------|--------------------|
|           |               | NPT 1/2" | NPT Y MUELLER 3/4" |
| 2"        | 60-77         | \$ 342   | \$ 357             |
| 2 ½" - 3" | 77-95         | \$ 360   | \$ 375             |
| 3" - 4"   | 98-119        | \$ 382   | \$ 397             |
| 4"        | 114-130       | \$ 395   | \$ 409             |
| 4"        | 120-135       | \$ 404   | \$ 418             |
| 6"        | 160-190       | \$ 437   | \$ 452             |
| 8"        | 200-230       | \$ 683   | \$ 683             |
| 8" - 10"  | 225-250       | \$ 729   | \$ 729             |
| 10"       | 270-300       | \$ 776   | \$ 776             |
| 12"       | 320-340       | \$ 791   | \$ 791             |
| 12"       | 335-365       | \$ 793   | \$ 793             |

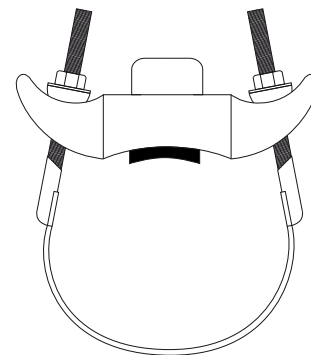

### ADAPTADOR BRIDADO UNIVERSAL Y COPLE UNIVERSAL DE RANGO AMPLIO

| DIMENSION | RANGO   | PRECIO    |
|-----------|---------|-----------|
|           |         | UNITARIO  |
| 2"        | 48-60   | \$ 546    |
|           | 59-72   | \$ 546    |
| 2 1/2"    | 72-85   | \$ 611    |
| 3"        | 88-103  | \$ 737    |
|           | 88-107  | \$ 969    |
| 4"        | 96-116  | \$ 816    |
|           | 109-130 | \$ 816    |
|           | 107-135 | \$ 1,136  |
| 6"        | 159-184 | \$ 1,304  |
|           | 157-189 | \$ 1,680  |
| 8"        | 192-210 | \$ 1,768  |
|           | 218-235 | \$ 1,768  |
|           | 214-249 | \$ 1,919  |
| 10"       | 245-267 | \$ 2,672  |
|           | 272-289 | \$ 2,425  |
|           | 272-308 | \$ 2,906  |
| 12"       | 315-332 | \$ 3,008  |
|           | 322-342 | \$ 3,494  |
|           | 325-365 | \$ 5,366  |
| 14"       | 351-378 | \$ 5,553  |
|           | 374-391 | \$ 5,906  |
| 16"       | 390-410 | \$ 5,998  |
|           | 390-435 | \$ 6,859  |
|           | 425-442 | \$ 7,515  |
| 18"       | 445-472 | \$ 9,858  |
|           | 480-510 | \$ 10,406 |
| 20"       | 500-532 | \$ 11,501 |
|           | 527-544 | \$ 12,323 |
| 24"       | 608-636 | \$ 14,787 |

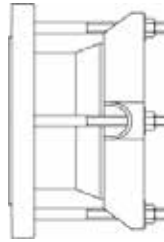

| DIMENSION | RANGO   | PRECIO   |
|-----------|---------|----------|
|           |         | UNITARIO |
| 2"        | 48-60   | \$ 569   |
|           | 59-73   | \$ 569   |
| 2 1/2"    | 72-85   | \$ 581   |
| 3"        | 88-103  | \$ 768   |
|           | 87-107  | \$ 868   |
| 3" - 4"   | 96-116  | \$ 836   |
| 4"        | 109-130 | \$ 868   |
|           | 107-135 | \$ 1,055 |
| 6"        | 159-184 | \$ 1,296 |
|           | 159-189 | \$ 1,470 |
| 8"        | 192-209 | \$ 1,995 |
|           | 218-235 | \$ 1,995 |
|           | 214-249 | \$ 2,415 |
|           | 230-247 | \$ 2,644 |
| 10"       | 245-267 | \$ 3,043 |
|           | 272-289 | \$ 3,331 |
|           | 272-308 | \$ 3,653 |
| 12"       | 315-332 | \$ 3,749 |
|           | 322-342 | \$ 3,762 |
| 12" - 14" | 324-365 | \$ 5,182 |
| 14"       | 351-378 | \$ 6,291 |
| 16"       | 390-410 | \$ 6,122 |
|           | 425-442 | \$ 6,432 |
| 18"       | 454-463 | \$ 6,803 |
|           | 476-493 | \$ 7,475 |
| 20"       | 500-532 | \$ 7,270 |
|           | 527-544 | \$ 8,519 |
| 24"       | 608-636 | \$ 9,860 |

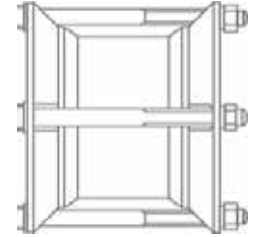

### ADAPTADOR BRIDADO PARA PEAD

| DIMENSION | Diam. Exterior Tubo PEAD | UNITARIO |
|-----------|--------------------------|----------|
| 3"        | 89                       | \$ 906   |
| 4"        | 114                      | \$ 1,267 |
| 6"        | 168                      | \$ 2,407 |

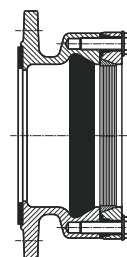

### VALVULAS DE MARIPOSA SIGMA FLOW

PRECIOS DE LISTA UNITARIOS EN PESOS

VALVULAS CON OPERADOR DE PALANCA

VALVULAS NO INCLUYEN OPERADOR DE ENGRANES

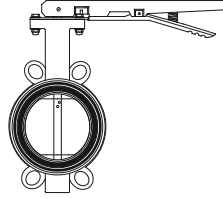

| Materiales     | Valvula Mariposa   |                |
|----------------|--------------------|----------------|
| <b>Cuerpo</b>  | Hierro Gris        | Hierro Gris    |
| <b>Disco</b>   | H. Ductil / Rilsan | Ac. Inoxidable |
| <b>Vástago</b> | Acero C/Zinc       | Ac. Inoxidable |
| <b>Asiento</b> | Buna               | EPDM / Buna    |
| <b>Presion</b> | 150 PSI            | 150 PSI        |
| <b>2"</b>      | \$ 682             | \$ 1,122       |
| <b>2 1/2"</b>  | \$ 760             | \$ 1,146       |
| <b>3"</b>      | \$ 870             | \$ 1,272       |
| <b>4"</b>      | \$ 1,190           | \$ 1,757       |
| <b>6"</b>      | \$ 1,842           | \$ 3,026       |
| <b>8"</b>      | \$ 2,909           | \$ 5,095       |
| <b>10"</b>     | \$ 4,386           | \$ 8,444       |
| <b>12"</b>     | \$ 5,957           | \$ 12,527      |

| Operador de engranes |          |
|----------------------|----------|
| <b>2"</b>            | \$ 719   |
| <b>2 1/2"</b>        | \$ 719   |
| <b>3"</b>            | \$ 719   |
| <b>4"</b>            | \$ 719   |
| <b>6"</b>            | \$ 719   |
| <b>8"</b>            | \$ 1,292 |
| <b>10"</b>           | \$ 1,292 |
| <b>12"</b>           | \$ 1,808 |

### VALVULAS DE MARIPOSA AWWA C504

PRECIOS DE LISTA UNITARIOS EN DOLARES USA

| Materiales     | Válvula Mariposa AWWA C504 |                |
|----------------|----------------------------|----------------|
| <b>Cuerpo</b>  | Hierro Dúctil              | Hierro Dúctil  |
| <b>Disco</b>   | H. Dúctil Perfil Al        | H. Dúctil      |
| <b>Vástago</b> | Ac. Inoxidable             | Ac. Inoxidable |
| <b>Asiento</b> | EPDM                       | EPDM           |
| <b>Presión</b> | 250 PSI                    | 150 PSI        |
| <b>4"</b>      | \$ 383                     |                |
| <b>6"</b>      | \$ 571                     |                |
| <b>8"</b>      | \$ 888                     |                |
| <b>10"</b>     | \$ 1,154                   |                |
| <b>12"</b>     | \$ 1,633                   |                |
| <b>14"</b>     | \$ 2,310                   |                |
| <b>16"</b>     | \$ 3,412                   |                |
| <b>18"</b>     | \$ 4,080                   |                |
| <b>20"</b>     | \$ 6,241                   |                |
| <b>24"</b>     | \$ 7,974                   |                |
| <b>30"</b>     |                            | \$ 18,777      |
| <b>36"</b>     |                            | \$ 23,571      |
| <b>42"</b>     |                            | \$ 30,992      |
| <b>48"</b>     |                            | \$ 40,818      |

### VALVULAS DE MARIPOSA MARCA BRAY

PRECIOS DE LISTA UNITARIOS EN DOLARES USA

VALVULAS NO INCLUYEN OPERADOR DE ENGRANES

|  | Materiales     | Tipo Oblea                  |                |                      |
|--|----------------|-----------------------------|----------------|----------------------|
|  | <b>Cuerpo</b>  | Hierro Dúctil               | Hierro Dúctil  |                      |
|  | <b>Disco</b>   | H. Ductil Nylon             | Ac. Inoxidable |                      |
|  | <b>Vástago</b> | Ac. Inoxidable              | Ac. Inoxidable |                      |
|  | <b>Asiento</b> | EPDM / Buna                 | EPDM / Buna    |                      |
| TAMAÑO VALVULA                             | PESO (LBS)     | INCLUYE OPERADOR DE PALANCA |                | Operador de Engranes |
| <b>2"</b>                                  | 6              | \$ 108                      | \$ 127         | \$ 167               |
| <b>2.5"</b>                                | 9              | \$ 116                      | \$ 131         | \$ 167               |
| <b>3"</b>                                  | 10             | \$ 123                      | \$ 146         | \$ 167               |
| <b>4"</b>                                  | 14             | \$ 151                      | \$ 191         | \$ 169               |
| <b>6"</b>                                  | 22             | \$ 214                      | \$ 282         | \$ 142               |
| <b>8"</b>                                  | 38             | \$ 312                      | \$ 526         | \$ 245               |
| <b>10"</b>                                 | 51             | \$ 451                      | \$ 858         | \$ 203               |
| <b>VASTAGO DESNUDO</b>                     |                |                             |                |                      |
| <b>12"</b>                                 | 71             | \$ 557                      | \$ 1,247       | \$ 203               |
| <b>14"</b>                                 | 114            | \$ 772                      | \$ 1,707       | \$ 275               |
| <b>16"</b>                                 | 193            | \$ 1,098                    | \$ 2,301       | \$ 314               |
| <b>18"</b>                                 | 222            | \$ 1,617                    | \$ 3,339       | \$ 597               |
| <b>20"</b>                                 | 315            | \$ 2,019                    | \$ 4,096       | \$ 597               |
| <b>Cuerpo Bridado Inc. Op. De Engranes</b> |                |                             |                |                      |
| <b>24"</b>                                 | 506            | \$ 5,745                    | \$ 10,926      | \$ 593               |
| <b>30"</b>                                 | 610            | \$ 10,865                   | \$ 20,154      | \$ 2,336             |
| <b>36"</b>                                 | 1185           | \$ 14,842                   | \$ 27,647      | \$ 2,403             |



### VALVULAS ELIMINADORAS DE AIRE Y VALVULAS DE ADMISION Y EXPULSION DE AIRE

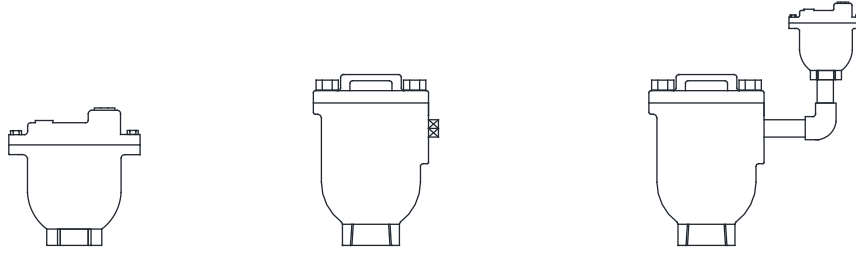

| DIMENSION | ELIMINADORAS | ADM. Y EXP DE AIRE | COMBINADAS |
|-----------|--------------|--------------------|------------|
|           | 200 PSI      | 200 PSI            | 200 PSI    |
| 1/2"      | \$ 998       | \$ 1,039           | \$ 2,037   |
| 3/4"      | \$ 998       | \$ 1,039           | \$ 2,037   |
| 1"        | \$ 998       | \$ 1,039           | \$ 2,037   |
| 2"        | \$ 1,237     | \$ 1,470           | \$ 2,721   |
| 3"        |              | \$ 2,606           | \$ 3,752   |
| 4"        |              | \$ 4,464           | \$ 6,108   |
| 6"        |              | \$ 8,149           | \$ 9,850   |
| 8"        |              | Cotizar            | Cotizar    |
| 10"       |              | Cotizar            | Cotizar    |

### VALVULAS AUTOMATICAS

#### CAMARA SENCILLA (Precios en Dolares USA)

| DIMENSION | REDUCT. DE PRESION | FLOTADOR | ALIVIO Y CTRA GPE ARIETE |
|-----------|--------------------|----------|--------------------------|
|           | 250 lbs            | 250 lbs  | 250 lbs                  |
| 2"        | Cotizar            | Cotizar  | Cotizar                  |
| 2 1/2"    | Cotizar            | Cotizar  | Cotizar                  |
| 3"        | Cotizar            | Cotizar  | Cotizar                  |
| 4"        | Cotizar            | Cotizar  | Cotizar                  |
| 6"        | Cotizar            | Cotizar  | Cotizar                  |
| 8"        | Cotizar            | Cotizar  | Cotizar                  |
| 10"       | Cotizar            | Cotizar  | Cotizar                  |
| 12"       | Cotizar            | Cotizar  | Cotizar                  |



#### CAMARA DOBLE, CUERPO EN "Y" (Precios en Dolares USA)

| DIMENSION | REDUCT. DE PRESION | FLOTADOR | ALIVIO Y CTRA GPE ARIETE |
|-----------|--------------------|----------|--------------------------|
|           | 250 lbs            | 250 lbs  | 250 lbs                  |
| 2"        | Cotizar            | Cotizar  | Cotizar                  |
| 2 1/2"    | Cotizar            | Cotizar  | Cotizar                  |
| 3"        | Cotizar            | Cotizar  | Cotizar                  |
| 4"        | Cotizar            | Cotizar  | Cotizar                  |
| 6"        | Cotizar            | Cotizar  | Cotizar                  |
| 8"        | Cotizar            | Cotizar  | Cotizar                  |
| 10"       | Cotizar            | Cotizar  | Cotizar                  |
| 12"       | Cotizar            | Cotizar  | Cotizar                  |



### ABRAZADERAS DE REPARACION DE ACERO INOXIDABLE

| DIAMETRO | LARGO | RANGO EN MM | PANEL  | PRECIO UNITARIO |
|----------|-------|-------------|--------|-----------------|
| 2        | 8     | 59-67       | Simple | \$ 895          |
| 2.5      | 8     | 69-76       | Simple | \$ 997          |
| 2.5      | 8     | 75-85       | Simple | \$ 997          |
| 3        | 8     | 88-94       | Simple | \$ 1,068        |
| 3        | 8     | 95-105      | Simple | \$ 1,160        |
| 4        | 8     | 113-123     | Simple | \$ 1,217        |
| 6        | 8     | 120-131     | Simple | \$ 1,255        |
| 4        | 8     | 126-136     | Simple | \$ 1,277        |
| 6        | 8     | 166-177     | Simple | \$ 1,563        |
| 6        | 8     | 174-184     | Simple | \$ 1,592        |
| 8        | 8     | 202-212     | Simple | \$ 1,804        |
| 8        | 8     | 218-228     | Simple | \$ 1,804        |
| 8        | 8     | 228-239     | Simple | \$ 1,804        |
| 10       | 12    | 246-257     | Simple | \$ 2,808        |
| 10       | 12    | 270-280     | Simple | \$ 3,229        |
| 10       | 12    | 280-291     | Simple | \$ 3,399        |
| 12       | 12    | 310-321     | Simple | \$ 3,563        |
| 12       | 12    | 320-330     | Simple | \$ 3,949        |
| 12       | 12    | 350-360     | Simple | \$ 4,483        |

| DIAMETRO | LARGO | RANGO EN MM | PANEL  | PRECIO UNITARIO |
|----------|-------|-------------|--------|-----------------|
| 4        | 8     | 113-133     | Doble  | \$ 1,436        |
| 4        | 8     | 120-141     | Doble  | \$ 1,507        |
| 8        | 8     | 228-249     | Doble  | \$ 2,142        |
| 10       | 12    | 273-293     | Doble  | \$ 3,399        |
| 12       | 12    | 335-356     | Doble  | \$ 4,424        |
| 14       | 12    | 383-403     | Doble  | \$ 5,572        |
| 16       | 12    | 436-456     | Doble  | \$ 6,664        |
| 18       | 12    | 488-508     | Doble  | \$ 7,133        |
| 20       | 16    | 547-567     | Doble  | \$ 11,689       |
| 24       | 24    | 625-655     | Triple | \$ 13,712       |
| 24       | 24    | 653-683     | Triple | \$ 14,790       |

30" y 36" Cotizar

### COPLE DE DESMONTAJE

| DIMENSION | PRECIO UNITARIO |
|-----------|-----------------|
| 2         | \$ 1,783        |
| 3         | \$ 2,746        |
| 4         | \$ 2,816        |
| 6         | \$ 4,303        |
| 8         | \$ 5,632        |
| 10        | \$ 8,449        |
| 12        | \$ 11,564       |
| 14        | \$ 14,959       |
| 16        | \$ 17,543       |
| 18        | \$ 18,837       |
| 20        | \$ 22,873       |
| 24        | \$ 28,725       |

### FILTROS "Y"

| DIMENSION | PRECIO UNITARIO |
|-----------|-----------------|
| 2         | \$ 1,504        |
| 2 ½       | \$ 1,943        |
| 3         | \$ 2,513        |
| 4         | \$ 3,495        |
| 6         | \$ 7,057        |
| 8         | \$ 13,600       |
| 10        | \$ 21,893       |
| 12        | \$ 28,296       |

### ALCANTARILLADO

| DESCRIPCION                   | PRECIO UNITARIO |
|-------------------------------|-----------------|
| BROCAL CON REJILLA DE DUCTIL  | \$ 3,944        |
| BROCAL CON REJILLA DE 80 KG.  | \$ 3,571        |
| BROCAL CON REJILLA DE 90 KG.  | \$ 4,018        |
| BROCAL CON REJILLA DE 110 KG. | \$ 4,911        |
| BROCAL CON REJILLA DE 130 KG. | \$ 5,357        |
| BROCAL CON REJILLA DE 150 KG. | \$ 6,696        |
| BROCAL CON REJILLA DE 160 KG. | \$ 7,143        |

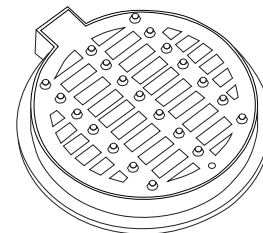

|                        |          |
|------------------------|----------|
| BROCAL CIEGO DE DUCTIL | \$ 3,944 |
| BROCAL CIEGO DE 85 KG  | \$ 3,571 |
| BROCAL CIEGO DE 95 KG  | \$ 4,018 |
| BROCAL CIEGO DE 115 KG | \$ 4,911 |
| BROCAL CIEGO DE 135 KG | \$ 5,804 |
| BROCAL CIEGO DE 160 KG | \$ 7,143 |

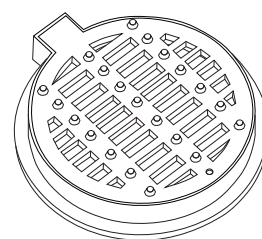

|  |           |
|--|-----------|
| MARCO CON TAPA AP 50 X 50 CM DUCTIL    | \$ 3,544  |
| MARCO CON TAPA 70 X 70 SADM DUCTIL     | \$ 10,310 |
| MARCO CON TAPA AP 50 X 50 CM DE 67 KG  | \$ 2,976  |
| MARCO CON TAPA AP 50 X 50 CM DE 80 KG  | \$ 3,434  |
| MARCO CON TAPA AP 50 X 50 CM DE 110 KG | \$ 4,688  |
| MARCO CON TAPA AP 50 X 50 CM DE 130 KG | \$ 5,357  |

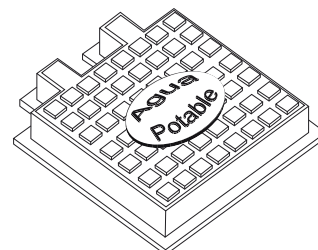

|   |          |
|---|----------|
| CAJA PARA LLAVE DE BANQUETA (BOTA LARGA)          | \$ 273   |
| CAJA PARA LLAVE DE BANQUETA (BOTA CORTA)          | \$ 183   |
| ESCALON PARA POZO DE VISITA LIGERO                | \$ 141   |
| ESCALON PARA POZO DE VISITA PESADO                | \$ 212   |
| COLADERA PLUVIAL                                  | \$ 3,434 |
| PLATO ROMPECHORRO COMPLETO                        | \$ 2,412 |
| REGISTRO PARA VALVULA TELESCOPICO DE 61 A 92 CM.  | Cotizar  |
| REGISTRO PARA VALVULA TELESCOPICO DE 92 A 122 CM. | Cotizar  |

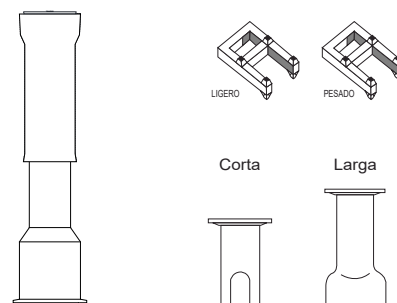

|   |          |
|---|----------|
| ARO Y TAPA CFE 84-B DE 105 KG             | \$ 5,652 |
| ARO Y TAPA CFE 84-B DE 120 KG             | \$ 6,460 |
| ARO Y TAPA CFE 84-B DE 135 KG             | \$ 7,267 |
| ARO Y TAPA CFE 84-B DE 110 KG CON BISAGRA | \$ 5,921 |
| ARO Y TAPA CFE 84-B DE 125 KG CON BISAGRA | \$ 6,729 |
| ARO Y TAPA CFE 84-B DE 140 KG CON BISAGRA | \$ 7,536 |

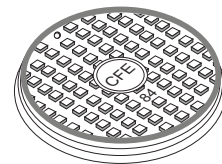

|  |           |
|--|-----------|
| MARCO TAPA CFE 84-A DE 150 KG                        | \$ 8,075  |
| MARCO TAPA CFE 84-A DE 180 KG                        | \$ 9,689  |
| MARCO Y TAPA CFE 84-A DE 190 KG CON BISAGRA          | \$ 10,228 |
| MARCO Y TAPA REFORZADO CFE 84-A DE 250 KG            | \$ 13,458 |
| MARCO Y TAPA REFORZADO CFE 84-A DE 250 KG C/ BISAGRA | \$ 13,458 |

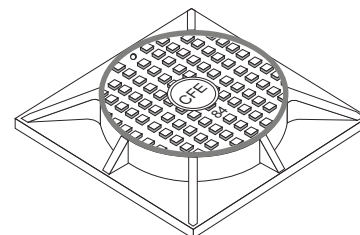

\*\*\*\*\* PRECIOS SUJETOS A CAMBIOS SIN PREVIO AVISO

### CONTRAMARCOS

| DIMENSION | CENTRADO O DESCENT. |          |
|-----------|---------------------|----------|
|           | SENCILLO            | DOBLE    |
| 4" x 0.90 | \$ 2,426            |          |
| 4" x 1.00 | \$ 2,550            |          |
| 4" x 1.10 | \$ 2,694            |          |
| 4" x 1.20 | \$ 2,828            |          |
| 4" x 1.30 | \$ 2,970            |          |
| 4" x 1.40 | \$ 3,102            | \$ 4,010 |
| 4" x 1.50 | \$ 3,232            | \$ 4,144 |
| 4" x 1.60 | \$ 3,387            | \$ 4,323 |
| 4" x 1.70 | \$ 3,529            | \$ 4,464 |
| 4" x 1.80 | \$ 3,657            | \$ 4,592 |
| 4" x 1.90 | \$ 3,791            | \$ 4,755 |
| 4" x 2.00 | \$ 3,954            | \$ 4,938 |
| 4" x 2.10 | \$ 4,084            | \$ 5,072 |

| DIMENSION | CENTRADO O DESCENT. |          |
|-----------|---------------------|----------|
|           | SENCILLO            | DOBLE    |
| 6" x 1.30 | \$ 4,571            |          |
| 6" x 1.40 | \$ 4,771            |          |
| 6" x 1.50 | \$ 4,973            | \$ 6,413 |
| 6" x 1.60 | \$ 5,270            | \$ 6,753 |
| 6" x 1.70 | \$ 5,466            | \$ 6,958 |
| 6" x 1.80 | \$ 5,672            | \$ 7,156 |
| 6" x 1.90 | \$ 5,883            | \$ 7,362 |
| 6" x 2.00 | \$ 6,122            | \$ 7,609 |
| 6" x 2.10 | \$ 6,328            | \$ 7,816 |
| 6" x 2.20 | \$ 6,531            | \$ 8,018 |
| 6" x 2.30 | \$ 7,257            | \$ 8,224 |
| 6" x 2.40 | \$ 7,624            | \$ 8,416 |

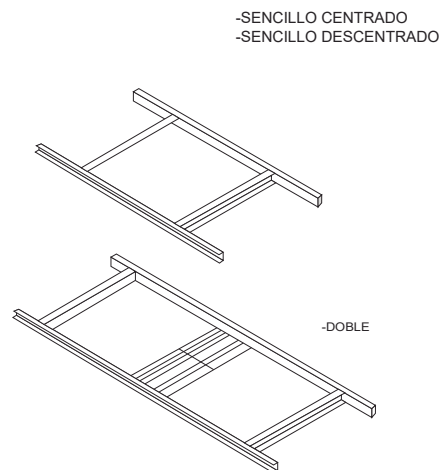

### ALCANTARILLADO POLIETILENO

| DESCRIPCION                                   | PRECIO UNITARIO |
|---|-----------------|
| BROCAL CIEGO POLIETILENO MEDIA DENSIDAD       | Cotizar         |
| BROCAL CON REJILLA POLIETILENO MEDIA DENSIDAD | Cotizar         |
| BROCAL CIEGO POLIETILENO HALO EXTENDIDO       | Cotizar         |
| MARCO CON TAPA AP 50 X 50 CM POLIETILENO      | Cotizar         |

### JUNTAS TIPO DRESER

DISPONIBLES DE 2" A 48"  
COTIZAR DE ACUERDO A DIAMETRO EXTERIOR DE TUBERIA